





<b>DESIGN NUMBER</b>	330130-001	
<b>CLASS</b>	23-02	
<b>OK PLAY HEALTHCARE PRIVATE LIMITED, 124, NEW MANGLAPURI, MEHRAULI, DELHI-110030</b>		
<b>DATE OF REGISTRATION</b>	17/06/2020	
<b>TITLE</b>	HAND WASH BASIN	
<b>PRIORITY NA</b>		
<b>DESIGN NUMBER</b>	330167-001	
<b>CLASS</b>	29-02	
<b>1.DR.P.SATISH KUMAR, ASSOCIATE PROFESSOR, UNIVERSITY COLLEGE OF ENGINEERING, OSMANIA UNIVERSITY, HYDERABAD, TELANGANA INDIA 500034 2. DR.SHAIK MAHABOOB, MUFAKHAM JAH COLLEGE OF ENGINEERING &amp; TECHNOLOGY, 8-2-249 TO 267, ROAD NUMBER 3 MOUNT PLEASANT, BANJARA HILLS, HYDERABAD, TELANGANA 3. DR.AKASH KUMAR BHOI, R&amp;D FACULTY ASSOCIATE, ASSISTANT PROFESSOR DEPARTMENT OF ELECTRICAL &amp; ELECTRONICS ENGINEERING, SIKKIM MANIPAL INSTITUTE OF TECHNOLOGY (SMIT), MAJITAR, EAST SIKKIM - , SIKKIM, INDIA 4. ARSHAD MOHAMMED, MUFAKHAM JAH COLLEGE OF ENGINEERING &amp; TECHNOLOGY, 8-2-249 TO 267, ROAD NUMBER 3 MOUNT PLEASANT, BANJARA HILLS, HYDERABAD, TELANGANA 500034</b>		
<b>DATE OF REGISTRATION</b>	18/06/2020	
<b>TITLE</b>	SMART SELF DISINFECTING FACE SHIELD	
<b>PRIORITY NA</b>		
<b>DESIGN NUMBER</b>	330537-001	
<b>CLASS</b>	12-08	
<b>CENTURION UNIVERSITY OF TECHNOLOGY &amp; MANAGEMENT (CUTM), AT-ALLURI NAGAR, PO-R.SITAPUR, VIA-UPPALADA, PARLAKHEMUNDI-761211, GAJAPATI DIST, ODISHA, INDIA</b>		
<b>DATE OF REGISTRATION</b>	29/06/2020	
<b>TITLE</b>	COMPACT COMMERCIAL ELECTRIC VEHICLE	
<b>PRIORITY NA</b>		

<b>DESIGN NUMBER</b>	322906-001		
<b>CLASS</b>	14-03		
<b>BEIJING XIAOMI MOBILE SOFTWARE CO., LTD., ROOM 01, FLOOR 9, RAINBOW CITY SHOPPING MALL II OF CHINA RESOURCES, NO. 68, QINGHE MIDDLE STREET, HAIDIAN DISTRICT, BEIJING 100085, CHINA</b>			
<b>DATE OF REGISTRATION</b>	23/10/2019		
<b>TITLE</b>	MOBILE PHONE		
<b>PRIORITY</b>			
<b>PRIORITY NUMBER</b>	<b>DATE</b>	<b>COUNTRY</b>	
201930196200.2	25/04/2019	CHINA	
<b>DESIGN NUMBER</b>	330538-001		
<b>CLASS</b>	12-11		
<b>CENTURION UNIVERSITY OF TECHNOLOGY &amp; MANAGEMENT (CUTM), AT-ALLURI NAGAR, PO-R.SITAPUR, VIA-UPPALADA, PARLAKHEMUNDI-761211, GAJAPATI DIST., ODISHA, INDIA</b>			
<b>DATE OF REGISTRATION</b>	29/06/2020		
<b>TITLE</b>	ELECTRIC BIKE		
<b>PRIORITY NA</b>			
<b>DESIGN NUMBER</b>	330559-001		
<b>CLASS</b>	16-02		
<b>SAMSUNG ELECTRONICS CO., LTD, 129, SAMSUNG-RO, YEONGTONG-GU, SUWON-SI, GYEONGGI-DO, REPUBLIC OF KOREA</b>			
<b>DATE OF REGISTRATION</b>	30/06/2020		
<b>TITLE</b>	BEAM PROJECTOR		
<b>PRIORITY</b>			
<b>PRIORITY NUMBER</b>	<b>DATE</b>	<b>COUNTRY</b>	
30-2020-0000250	03/01/2020	REPUBLIC OF KOREA	

## Design Application Details

**Application Number:**

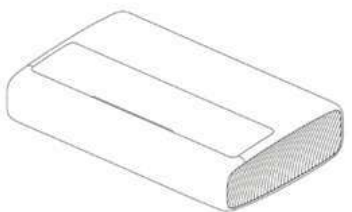
348484-001

**Cbr Number:**

206829

**Cbr Date:**

27/08/2021 08:27:03

**Applicant Name:**

1. Centurion University of technology and management      2. Tapan kumar padhy  
3. Hariharan Nelli      4. Dinesh tej kovelakonda      5. Suman Kumar Sudhanshu

## Design Application Status

**Application Status:**

Design Accepted and Published, Journal No is 02/2023 and Journal Date is 13/01/2023

[Back \(/DesignApplicationStatus/\)](#)

Disclaimer: Application status is available for the application filed on or after 1st April 2009 with application no 222230. The information under " Design Application Status" is dynamically retrieved and is under testing, therefore the information retrieved by this system is not valid for any legal proceedings under the Design Act 2000. In case of any discrepancy you may contact the appropriate Patent Office or send your comments to following email IDs:

Design Office, Kolkata : [controllerdesign.ipo@nic.in](mailto:controllerdesign.ipo@nic.in)

Controller General of Patents, Designs and Trademarks

## Design Application Details

**Application Number:**

348485-001

**Cbr Number:**

206829

**Cbr Date:**

27/08/2021 08:27:03

**Applicant Name:**

1. Centurion University of Technology and Management      2. Tapan kumar padhy  
3. Hariharan Nelli      4. Dinesh Tej Kovelakonda      5. Suman Kumar Sudhanshu

## Design Application Status

**Application Status:**

Design Accepted and Published, Journal No is 09/2023 and Journal Date is 03/03/2023

[Back \(/DesignApplicationStatus/\)](#)

Disclaimer: Application status is available for the application filed on or after 1st April 2009 with application no 222230. The information under " Design Application Status" is dynamically retrieved and is under testing, therefore the information retrieved by this system is not valid for any legal proceedings under the Design Act 2000. In case of any discrepancy you may contact the appropriate Patent Office or send your comments to following email IDs:

Design Office, Kolkata : [controllerdesign.ipo@nic.in](mailto:controllerdesign.ipo@nic.in)

Controller General of Patents, Designs and Trademarks

## Design Application Details

**Application Number:**

348487-001

**Cbr Number:**

206829

**Cbr Date:**

27/08/2021 08:27:03

**Applicant Name:**

1. Centurion University of Technology and Management      2. Tapan Kumar Padhy  
3. Hariharan Nelli      4. Dinesh Tej Kovelakonda      5. Suman Kumar Sudhanshu

## Design Application Status

**Application Status:**

Design Accepted and Published, Journal No is 02/2023 and Journal Date is 13/01/2023

[Back \(/DesignApplicationStatus/\)](/DesignApplicationStatus/)

Disclaimer: Application status is available for the application filed on or after 1st April 2009 with application no 222230. The information under " Design Application Status" is dynamically retrieved and is under testing, therefore the information retrieved by this system is not valid for any legal proceedings under the Design Act 2000. In case of any discrepancy you may contact the appropriate Patent Office or send your comments to following email IDs:

Design Office, Kolkata : [controllerdesign.ipo@nic.in](mailto:controllerdesign.ipo@nic.in)

Controller General of Patents, Designs and Trademarks

## Design Application Details

**Application Number:**

348489-001

**Cbr Number:**

206829

**Cbr Date:**

27/08/2021 08:27:03

**Applicant Name:**

1. Centurion University of Technology and Management      2. Tapan Kumar Padhy  
3. Hariharan Nelli      4. Dinesh Tej Kovelakonda      5. Suman Kumar Sudhanshu

## Design Application Status

**Application Status:**

Design Accepted and Published, Journal No is 01/2023 and Journal Date is 06/01/2023

[Back \(/DesignApplicationStatus/\)](#)

Disclaimer: Application status is available for the application filed on or after 1st April 2009 with application no 222230. The information under " Design Application Status" is dynamically retrieved and is under testing, therefore the information retrieved by this system is not valid for any legal proceedings under the Design Act 2000. In case of any discrepancy you may contact the appropriate Patent Office or send your comments to following email IDs:

Design Office, Kolkata : [controllerdesign.ipo@nic.in](mailto:controllerdesign.ipo@nic.in)

Controller General of Patents, Designs and Trademarks

## Design Application Details

**Application Number:**

348490-001

**Cbr Number:**

206829

**Cbr Date:**

27/08/2021 08:27:03

**Applicant Name:**

1. Centurion University of Technology and Management      2. Tapan Kumar Padhy  
3. Hariharan Nelli      4. Dinesh Tej Kovelakonda      5. Suman Kumar Sudhanshu

## Design Application Status

**Application Status:**



Design Accepted and Published, Journal No is 08/2023 and Journal Date is 24/02/2023

[Back \(/DesignApplicationStatus/\)](#)

Disclaimer: Application status is available for the application filed on or after 1st April 2009 with application no 222230. The information under " Design Application Status" is dynamically retrieved and is under testing, therefore the information retrieved by this system is not valid for any legal proceedings under the Design Act 2000. In case of any discrepancy you may contact the appropriate Patent Office or send your comments to following email IDs:

Design Office, Kolkata : [controllerdesign.ipo@nic.in](mailto:controllerdesign.ipo@nic.in)

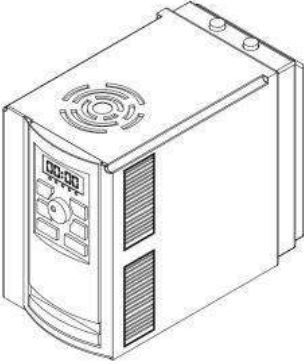
Controller General of Patents, Designs and Trademarks

<b>Design Number</b>	375060-001	
<b>Class</b>	26-05	
<b>M/S EVERSHINE STAGE LIGHTS AND EQUIPMENTS M/S EVERSHINE STAGE LIGHTS AND EQUIPMENTS, FLOOR 1ST, 5073/11, JAPANI BUILDING, SUBZI MANDI LANDMARK, OPP ROSHANARA PARK AND GARDEN, ROSHANARA ROAD, NORTH DELHI, DELHI-110007</b>		
<b>Date of Registration</b>	05/12/2022	
<b>Title</b>	LED PAR LIGHT HOUSING	
<b>Priority NA</b>		
<b>Design Number</b>	375062-001	
<b>Class</b>	13-02	
<b>1.Dr.Sushil Kumar Bhoi Assistant Professor, Department of Electrical Engineering, Government College of Engineering Kalahandi, Bhawanipatna, Odisha, India. Pin Code:766003 2. Dr.Asini Kumar Baliarsingh Associate Professor, Department of Electrical Engineering, Government College of Engineering Kalahandi, Bhawanipatna, Odisha, India. Pin Code:766003 3. Dr.Deepa Das Assistant Professor, Department of Electronics and Telecommunication Engineering, Government College of Engineering Kalahandi, Bhawanipatna, Odisha, India. Pin Code:766003 4. Dr.Ashish Kumar Sarangi Assistant Professor, Department of Chemistry, School of Applied Science, Centurion University of Technology and Management, Balangir, Odisha, India. Pin Code:767001</b>		
<b>Date of Registration</b>	05/12/2022	
<b>Title</b>	Frequency Converter Unit	
<b>Priority NA</b>		
<b>Design Number</b>	375067-001	
<b>Class</b>	02-02	
<b>SABYASACHI CALCUTTA LLP 80/2 Topsia Road (South), Kolkata-700046, West Bengal.</b>		
<b>Date of Registration</b>	05/12/2022	
<b>Title</b>	LADIES GARMENT	
<b>Priority NA</b>		



<b>Design Number</b>	370586-001	
<b>Class</b>	04-02	
1.RITU MAITY RITU MAITY, CENTRAL TOOL ROOM & TRAINING CENTRE, B-36, CHANDAKA INDUSTRIAL AREA, PATIA, NEAR INFOCITY SQUARE, BHUBANESWAR-751024, DIST-KHORDHA, ODISHA 2. SHIV SHANKAR KUMAR PRASAD SHIV SHANKAR KUMAR PRASAD, CENTRAL TOOL ROOM & TRAINING CENTRE, B-36, CHANDAKA INDUSTRIAL AREA, PATIA, NEAR INFOCITY SQUARE, BHUBANESWAR-751024, DIST-KHORDHA, ODISHA		
<b>Date of Registration</b>	09/09/2022	
<b>Title</b>	DETACHABLE TOOTHBRUSH	
<b>Priority NA</b>		
<b>Design Number</b>	372607-001	
<b>Class</b>	16-06	
1.Dr. Preetam Suman VIT Bhopal University, Indore Road, Bhopal, Madhya Pradesh 466114, India 2. Dr. Varshali Jaiswal VIT Bhopal University, Indore Road, Bhopal, Madhya Pradesh 466114, India 3. Dr. S. Poonkuntran VIT Bhopal University, Indore Road, Bhopal, Madhya Pradesh 466114, India 4. Dr. Rajit Nair VIT Bhopal University, Indore Road, Bhopal, Madhya Pradesh 466114, India		
<b>Date of Registration</b>	15/10/2022	
<b>Title</b>	SMART SPECTACLE FOR VISUALLY CHALLENGED PERSONS	
<b>Priority NA</b>		
<b>Design Number</b>	372612-001	
<b>Class</b>	15-10	
1.Dr. S. Sivaprasad Associate Professor, Department of Pharmaceutics, MNR College of Pharmacy, MNR Nagar, Narsapur Road, Sangareddy-502294. 2. Dr. Nihar Ranjan Kar Assistant Professor, School of Pharmacy. Centurion University of Technology and Management, Paikasta, Gopalpur, Balasore, Odisha. 3. Dr.Rasapelly Ramesh Kumar Associate Professor, Department of, Pharmaceutical Chemistry, Marri Laxman Reddy Institute of Pharmacy, Dundigal (M), Medchal (D) Hyderabad -500043 4. Alapati Sahithi Assistant Professor, Department of, Pharmaceutical Analysis, Nalla Narasimha Reddy Education Society's Group of Institutions, Via Narapally, Ghatkesar Mandal, Korremula Rd, Hyderabad, Telangana 500088		
<b>Date of Registration</b>	15/10/2022	
<b>Title</b>	BLISTER PACKAGING MACHINE FOR PHARMACEUTICAL PURPOSE	
<b>Priority NA</b>		



ORIGINAL

मूल/No : 124911



भारत सरकार  
GOVERNMENT OF INDIA  
पेटेंट कार्यालय  
THE PATENT OFFICE

डिजाइन के पंजीकरण का प्रमाणपत्र  
CERTIFICATE OF REGISTRATION OF DESIGN

डिजाइन सं. / Design No. : 372612-001  
तारीख / Date : 15/10/2022  
पारस्परिकता तारीख / Reciprocity Date\* :  
देश / Country :

प्रमाणित किया जाता है कि संलग्न प्रति में वर्णित डिजाइन जो **BLISTER PACKAGING MACHINE FOR PHARMACEUTICAL PURPOSE** से संबंधित है, का पंजीकरण, श्रेणी 15-10 में 1.Dr. S. Sivaprasad 2. Dr. Nihar Ranjan Kar 3.Dr.Rasapelly Ramesh Kumar 4.Alapati Sahithi के नाम में उपर्युक्त संख्या और तारीख में कर लिया गया है।

Certified that the design of which a copy is annexed hereto has been registered as of the number and date given above in class 15-10 in respect of the application of such design to **BLISTER PACKAGING MACHINE FOR PHARMACEUTICAL PURPOSE** in the name of 1.Dr. S. Sivaprasad 2. Dr. Nihar Ranjan Kar 3.Dr.Rasapelly Ramesh Kumar 4.Alapati Sahithi.

डिजाइन अधिनियम, 2000 तथा डिजाइन नियम, 2001 के अध्याधीन प्रावधानों के अनुसरण में।

In pursuance of and subject to the provisions of the Designs Act, 2000 and the Designs Rules, 2001.

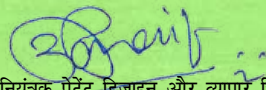

INTELLECTUAL  
PROPERTY INDIA  
PATENTS | DESIGNS | TRADE MARKS  
GEOGRAPHICAL INDICATIONS

निर्गमन की तारीख/Date of Issue : 12/01/2023

  
महानियंत्रक पेटेंट डिजाइन और व्यापार चिह्न  
Controller General of Patents, Designs and Trade Marks

पारस्परिकता तारीख (यदि कोई हो) जिसकी अनुमति देश के नाम पर की गई है। डिजाइन का सत्त्वाधिकार पंजीकरण की तारीख से दस वर्षों के लिए होगा जिसका विस्तार, अधिनियम एवं नियम के निबंधनों के अधीन, पाँच वर्षों की अतिरिक्त अवधि के लिए किया जा सकेगा। इस प्रमाण पत्र का उपयोग विधिक कार्यवाहियों अथवा विदेश में पंजीकरण प्राप्त करने के लिए नहीं हो सकता है।

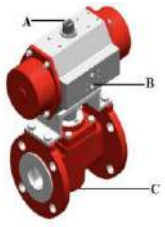
\*The reciprocity date (if any) which has been allowed and the name of the country. Copyright in the design will subsist for ten years from the date of Registration, and may under the terms of the Act and Rules, be extended for a further period of five years. This Certificate is not for use in legal proceedings or for obtaining registration abroad.

<b>Design Number</b>	377838-001	
<b>Class</b>	23-01	
<b>UNIFLOW CONTROLS PRIVATE LIMITED Q 49/149, JAI MATA DI COMPOUND, THANE- BHIWANDI AGRA ROAD, KALHER VILLAGE, BHIWANDI, DIST. THANE-421302, MAHARASHTRA, INDIA.</b>		
<b>Date of Registration</b>	23/01/2023	
<b>Title</b>	V-NOTCH BALL VALVE	
<b>Priority NA</b>		
<b>Design Number</b>	377840-001	
<b>Class</b>	23-01	
<b>UNIFLOW CONTROLS PRIVATE LIMITED Q 49/149, JAI MATA DI COMPOUND, THANE- BHIWANDI AGRA ROAD, KALHER VILLAGE, BHIWANDI, DIST. THANE-421302, MAHARASHTRA, INDIA.</b>		
<b>Date of Registration</b>	23/01/2023	
<b>Title</b>	LINED PLUG VALVE	
<b>Priority NA</b>		
<b>Design Number</b>	377851-001	
<b>Class</b>	09-09	
<b>1.Dr. Tridibesh Nag Associate Professor &amp; HOD, Department of Electrical Engineering, Netaji Subhash Engineering College, Techno City, Garia, West Bengal, Kolkata - 700152 2. Dr. Subrata Biswas Associate Professor, Department of Electrical Engineering, Netaji Subhash Engineering College, Techno City, Garia, West Bengal, Kolkata - 700152 3. Mr. Silpi Bose Assistant Professor, Department of Computer Science and Engineering, Netaji Subhash Engineering College, Techno City, Garia, West Bengal, Kolkata - 700152 4. Dr. Prafulla Kumar Panda Associate Professor &amp; HOD, Department of Civil Engineering, Centurion University of Technology and Management, R.Sitapur, Odisha- 761211 , et al.</b>		
<b>Date of Registration</b>	23/01/2023	
<b>Title</b>	IOT BASED FOOD WASTE RECYCLING MACHINE	
<b>Priority NA</b>		



Controller General of Patents, Designs and Trademarks  
Department of Industrial Policy and Promotion  
Ministry of Commerce and Industry



### Design Application Details

**Application Number:** 376914-001  
**Cbr Number:** 200329  
**Cbr Date:** 07/01/2023 05:45:00  
**Applicant Name:**  
**1. Dr. Debani Prasad Mishra**  
**2. Dr. Arun Kumar Sahoo**  
**3. Dr. Ramesh Chandra Mohanty**  
**4. Prof. Nimay Chandra Giri**

### Design Application Status

**Application Status:** Design Accepted and Published, Journal No is 11/2023 and Journal Date is 17/03/2023

[Back](#)

<b>Design Number</b>	377766-001		
<b>Class</b>	12-16		
<b>Premier Seals (India) Pvt Ltd 20/8, D1 Block, MIDC Chinchwad, Pune-411019, Maharashtra, India.</b>			
<b>Date of Registration</b>	21/01/2023		
<b>Title</b>	SWITCHABLE TORQUE ROD		
<b>Priority NA</b>			
<b>Design Number</b>	377789-001		
<b>Class</b>	09-01		
<b>Dart Industries Inc. 14901 S. Orange Blossom Trail, Orlando, Florida 32837, U.S.A.</b>			
<b>Date of Registration</b>	21/01/2023		
<b>Title</b>	Drinking Tumbler with Cover		
<b>Priority</b>			
<b>Priority Number</b>	<b>Date</b>	<b>Country</b>	
29/851,370	27/08/2022	U.S.A.	
<b>Design Number</b>	377791-001		
<b>Class</b>	15-09		
<b>1.Dr.BIJAYA BIJETA NAYAK Assistant Professor, School of Mechanical Engineering, KIIT Deemed to be University, KIIT Road, Patia, Bhubaneswar, Odisha- 751024, India. 2. Dr.SASMITA SAHU Assistant Professor, School of Mechanical Engineering, KIIT Deemed to be University, KIIT Road, Patia, Bhubaneswar, Odisha- 751024, India. 3. Dr. SANTOSH KUMAR NAYAK Associate Professor, School of Mechanical Engineering, KIIT Deemed to be University, KIIT Road, Patia, Bhubaneswar, Odisha- 751024, India. 4. Ms. DEBASHREE DEBADATTA BEHERA Assistant Professor, Mechanical Engineering Department, Centurion University of Technology and Management, Odisha-761211, India. , et al.</b>			
<b>Date of Registration</b>	21/01/2023		
<b>Title</b>	POWDER MANUFACTURING UNIT		
<b>Priority NA</b>			



ORIGINAL

मूल/No : 131380



भारत सरकार  
GOVERNMENT OF INDIA  
पेटेंट कार्यालय  
THE PATENT OFFICE

डिजाइन के पंजीकरण का प्रमाणपत्र  
CERTIFICATE OF REGISTRATION OF DESIGN

डिजाइन सं. / Design No. : 376903-001  
तारीख / Date : 07/01/2023  
पारस्परिकता तारीख / Reciprocity Date\* :  
देश / Country :

प्रमाणित किया जाता है कि संलग्न प्रति में वर्णित डिजाइन जो **IOT BASED AGRICULTURE ROBOT FOR PESTICIDES SPRAYING** से संबंधित है, का पंजीकरण, श्रेणी 15-03 में 1.Prof. Prasheet Mishra 2. Dr.Taraprasad Mohapatra 3.Prof.Sudhansu Sekhar Mishra 4.Prof. Nimay Chandra Giri के नाम में उपर्युक्त संख्या और तारीख में कर लिया गया है।

Certified that the design of which a copy is annexed hereto has been registered as of the number and date given above in class 15-03 in respect of the application of such design to **IOT BASED AGRICULTURE ROBOT FOR PESTICIDES SPRAYING** in the name of 1.Prof. Prasheet Mishra 2. Dr.Taraprasad Mohapatra 3.Prof.Sudhansu Sekhar Mishra 4.Prof. Nimay Chandra Giri.

डिजाइन अधिनियम, 2000 तथा डिजाइन नियम, 2001 के अध्याधीन प्रावधानों के अनुसरण में।

In pursuance of and subject to the provisions of the Designs Act, 2000 and the Designs Rules, 2001.

INTELLECTUAL  
PROPERTY INDIA  
PATENTS | DESIGNS | TRADE MARKS  
GEOGRAPHICAL INDICATIONS

निर्गमन की तारीख/Date of Issue : 20/03/2023

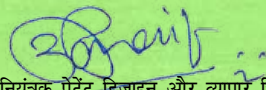
  
महानियंत्रक पेटेंट डिजाइन और व्यापार चिह्न  
Controller General of Patents, Designs and Trade Marks

पारस्परिकता तारीख (यदि कोई हो) जिसकी अनुमति देश के नाम पर की गई है। डिजाइन का सत्त्वाधिकार पंजीकरण की तारीख से दस वर्षों के लिए होगा जिसका विस्तार, अधिनियम एवं नियम के निबंधनों के अधीन, पाँच वर्षों की अतिरिक्त अवधि के लिए किया जा सकेगा। इस प्रमाण पत्र का उपयोग विधिक कार्यवाहियों अथवा विदेश में पंजीकरण प्राप्त करने के लिए नहीं हो सकता है।

\*The reciprocity date (if any) which has been allowed and the name of the country. Copyright in the design will subsist for ten years from the date of Registration, and may under the terms of the Act and Rules, be extended for a further period of five years. This Certificate is not for use in legal proceedings or for obtaining registration abroad.



ORIGINAL

मूल/No : 131381



भारत सरकार  
GOVERNMENT OF INDIA  
पेटेंट कार्यालय  
THE PATENT OFFICE

डिजाइन के पंजीकरण का प्रमाणपत्र  
CERTIFICATE OF REGISTRATION OF DESIGN

डिजाइन सं. / Design No. : 376944-001  
तारीख / Date : 07/01/2023  
पारस्परिकता तारीख / Reciprocity Date\* :  
देश / Country :

प्रमाणित किया जाता है कि संलग्न प्रति में वर्णित डिजाइन जो **IOT BASED CAMERA FOR HEALTHCARE MANAGEMENT** से संबंधित है, का पंजीकरण, श्रेणी **16-01** में 1.Prof. Sima Das 2. Prof. Susmita Chakrabarty 3.Ms. Solanki Mitra 4.Prof. Nimay Chandra Giri के नाम में उपर्युक्त संख्या और तारीख में कर लिया गया है।

Certified that the design of which a copy is annexed hereto has been registered as of the number and date given above in class **16-01** in respect of the application of such design to **IOT BASED CAMERA FOR HEALTHCARE MANAGEMENT** in the name of 1.Prof. Sima Das 2. Prof. Susmita Chakrabarty 3.Ms. Solanki Mitra 4.Prof. Nimay Chandra Giri.

डिजाइन अधिनियम, 2000 तथा डिजाइन नियम, 2001 के अध्याधीन प्रावधानों के अनुसरण में।

In pursuance of and subject to the provisions of the Designs Act, 2000 and the Designs Rules, 2001.

INTELLECTUAL  
PROPERTY INDIA  
PATENTS | DESIGNS | TRADE MARKS  
GEOGRAPHICAL INDICATIONS

निर्गमन की तारीख/Date of Issue : 20/03/2023

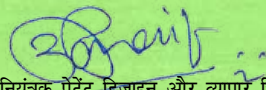
  
महानियंत्रक पेटेंट डिजाइन और व्यापार चिह्न  
Controller General of Patents, Designs and Trade Marks

पारस्परिकता तारीख (यदि कोई हो) जिसकी अनुमति देश के नाम पर की गई है। डिजाइन का सत्त्वाधिकार पंजीकरण की तारीख से दस वर्षों के लिए होगा जिसका विस्तार, अधिनियम एवं नियम के निबंधनों के अधीन, पाँच वर्षों की अतिरिक्त अवधि के लिए किया जा सकेगा। इस प्रमाण पत्र का उपयोग विधिक कार्यवाहियों अथवा विदेश में पंजीकरण प्राप्त करने के लिए नहीं हो सकता है।

\*The reciprocity date (if any) which has been allowed and the name of the country. Copyright in the design will subsist for ten years from the date of Registration, and may under the terms of the Act and Rules, be extended for a further period of five years. This Certificate is not for use in legal proceedings or for obtaining registration abroad.



ORIGINAL

मूल/No : 132036



भारत सरकार  
GOVERNMENT OF INDIA  
पेटेंट कार्यालय  
THE PATENT OFFICE  
डिजाइन के पंजीकरण का प्रमाणपत्र  
CERTIFICATE OF REGISTRATION OF DESIGN

डिजाइन सं. / Design No. : 357339-001  
तारीख / Date : 26/01/2022  
पारस्परिकता तारीख / Reciprocity Date\* :  
देश / Country :

प्रमाणित किया जाता है कि संलग्न प्रति में वर्णित डिजाइन जो **E-RICKSHAW** से संबंधित है, का पंजीकरण, श्रेणी **12-11** में 1.Centurion University Of Technology & Management (Cutm) 2. N.Laxmidhar Reddy 3.Sipalin Nayak के नाम में उपर्युक्त संख्या और तारीख में कर लिया गया है।

Certified that the design of which a copy is annexed hereto has been registered as of the number and date given above in class **12-11** in respect of the application of such design to **E-RICKSHAW** in the name of 1.Centurion University Of Technology & Management (Cutm) 2. N.Laxmidhar Reddy 3.Sipalin Nayak.

डिजाइन अधिनियम, 2000 तथा डिजाइन नियम, 2001 के अध्याधीन प्रावधानों के अनुसरण में।

In pursuance of and subject to the provisions of the Designs Act, 2000 and the Designs Rules, 2001.

INTELLECTUAL  
PROPERTY INDIA  
PATENTS | DESIGNS | TRADE MARKS  
GEOGRAPHICAL INDICATIONS

निर्गमन की तारीख/Date of Issue : 28/03/2023

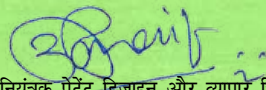
  
महानियंत्रक पेटेंट डिजाइन और व्यापार चिह्न  
Controller General of Patents, Designs and Trade Marks

पारस्परिकता तारीख (यदि कोई हो) जिसकी अनुमति देश के नाम पर की गई है। डिजाइन का सत्त्वाधिकार पंजीकरण की तारीख से दस वर्षों के लिए होगा जिसका विस्तार, अधिनियम एवं नियम के निबंधनों के अधीन, पाँच वर्षों की अतिरिक्त अवधि के लिए किया जा सकेगा। इस प्रमाण पत्र का उपयोग विधिक कार्यवाहियों अथवा विदेश में पंजीकरण प्राप्त करने के लिए नहीं हो सकता है।

\*The reciprocity date (if any) which has been allowed and the name of the country. Copyright in the design will subsist for ten years from the date of Registration, and may under the terms of the Act and Rules, be extended for a further period of five years. This Certificate is not for use in legal proceedings or for obtaining registration abroad.



## Design Application Details

<b>Application Number:</b>	346872-001
<b>Cbr Number:</b>	205695
<b>Cbr Date:</b>	28/07/2021 09:09:37
<b>Applicant Name:</b>	<ol style="list-style-type: none"><li>1. Centurion University of Technology &amp; Management (CUTM)</li><li>2. Dr.Nitesh Dhar Badgayan</li><li>3. Mr.E.Krushna Murty</li><li>4. Mr.Jitendra Pramanik</li></ol>

## Design Application Status

**Application Status:** Design Accepted and Published, Journal No is 52/2022 and Journal Date is 30/12/2022

[Back](#)



ORIGINAL

मूल/No : 133388



भारत सरकार  
GOVERNMENT OF INDIA  
पेटेंट कार्यालय  
THE PATENT OFFICE

डिजाइन के पंजीकरण का प्रमाणपत्र  
CERTIFICATE OF REGISTRATION OF DESIGN

डिजाइन सं. / Design No. : 368071-001  
तारीख / Date : 20/07/2022  
पारस्परिकता तारीख / Reciprocity Date\* :  
देश / Country :

प्रमाणित किया जाता है कि संलग्न प्रति में वर्णित डिजाइन जो **SOLAR OPTICAL DESALINATION UNIT** से संबंधित है, का पंजीकरण, श्रेणी **23-03** में 1.Dr. Bijaya Bijeta Nayak 2. Dr. Shiv Sankar Das 3.Ms. Debashree Debadatta Behera 4.Mr. Soumya Ranjan Giri के नाम में उपर्युक्त संख्या और तारीख में कर लिया गया है।

Certified that the design of which a copy is annexed hereto has been registered as of the number and date given above in class **23-03** in respect of the application of such design to **SOLAR OPTICAL DESALINATION UNIT** in the name of 1.Dr. Bijaya Bijeta Nayak 2. Dr. Shiv Sankar Das 3.Ms. Debashree Debadatta Behera 4.Mr. Soumya Ranjan Giri.

डिजाइन अधिनियम, 2000 तथा डिजाइन नियम, 2001 के अध्याधीन प्रावधानों के अनुसरण में।

In pursuance of and subject to the provisions of the Designs Act, 2000 and the Designs Rules, 2001.

INTELLECTUAL  
PROPERTY INDIA  
PATENTS | DESIGNS | TRADE MARKS  
GEOGRAPHICAL INDICATIONS

निर्गमन की तारीख/Date of Issue : 19/04/2023

  
महानियंत्रक पेटेंट-डिजाइन और व्यापार चिह्न  
Controller General of Patents, Designs and Trade Marks

पारस्परिकता तारीख (यदि कोई हो) जिसकी अनुमति देश के नाम पर की गई है। डिजाइन का सत्त्वाधिकार पंजीकरण की तारीख से दस वर्षों के लिए होगा जिसका विस्तार, अधिनियम एवं नियम के निबंधनों के अधीन, पाँच वर्षों की अतिरिक्त अवधि के लिए किया जा सकेगा। इस प्रमाण पत्र का उपयोग विधिक कार्यवाहियों अथवा विदेश में पंजीकरण प्राप्त करने के लिए नहीं हो सकता है।

\*The reciprocity date (if any) which has been allowed and the name of the country. Copyright in the design will subsist for ten years from the date of Registration, and may under the terms of the Act and Rules, be extended for a further period of five years. This Certificate is not for use in legal proceedings or for obtaining registration abroad.



Intellectual  
Property  
Office

## Certificate of Registration for a UK Design

Design number: 6279508

Grant date: 11 May 2023

Registration date: 30 April 2023

### This is to certify that,

in pursuance of and subject to the provision of Registered Designs Act 1949, the design of which a representation or specimen is attached, had been registered as of the date of registration shown above in the name of

Dr. Muppaneni Srikanth, Dr. Chinmaya Mahapatra, Mr. Bikash Ranjan Jena, Dr.

Priyanka Debta , Chatlapelli Kishore , Deepak Shrivastava, Pragati Baghel,

Satyabrata Jena

in respect of the application of such design to:

EXTENSIVE DEVICE TO ANALYZE AND DESIGN TO FORMULATE HERBAL

DRUGS

International Design Classification:

Version: 14-2023

Class: 24 MEDICAL AND LABORATORY EQUIPMENT

Subclass: 01 APPARATUS AND EQUIPMENT FOR DOCTORS, HOSPITALS  
AND LABORATORIES

### Adam Williams

Comptroller-General of Patents, Designs and Trade Marks

Intellectual Property Office

The attention of the Proprietor(s) is drawn to the important notes overleaf.





ORIGINAL

मूल/No : 136833



भारत सरकार  
GOVERNMENT OF INDIA  
पेटेंट कार्यालय  
THE PATENT OFFICE

डिजाइन के पंजीकरण का प्रमाणपत्र  
CERTIFICATE OF REGISTRATION OF DESIGN

डिजाइन सं. / Design No. : 348483-001  
तारीख / Date : 27/08/2021  
पारस्परिकता तारीख / Reciprocity Date\* :  
देश / Country :

प्रमाणित किया जाता है कि संलग्न प्रति में वर्णित डिजाइन जो **CENTERTABLE** से संबंधित है, का पंजीकरण, श्रेणी **06-03** में 1.Centurion University Of Technology And Management 2. Tapan Kumar Padhy 3.Hariharan Nelli 4.Dinesh Tej Kovelakonda 5.Suman Kumar Sudhanshu के नाम में उपर्युक्त संख्या और तारीख में कर लिया गया है।

Certified that the design of which a copy is annexed hereto has been registered as of the number and date given above in class **06-03** in respect of the application of such design to **CENTERTABLE** in the name of 1.Centurion University Of Technology And Management 2. Tapan Kumar Padhy 3.Hariharan Nelli 4.Dinesh Tej Kovelakonda 5.Suman Kumar Sudhanshu.

डिजाइन अधिनियम, 2000 तथा डिजाइन नियम, 2001 के अध्याधीन प्रावधानों के अनुसरण में।

In pursuance of and subject to the provisions of the Designs Act, 2000 and the Designs Rules, 2001.

INTELLECTUAL  
PROPERTY INDIA  
PATENTS | DESIGNS | TRADE MARKS  
GEOGRAPHICAL INDICATIONS

निर्गमन की तारीख/Date of Issue : 23/05/2023

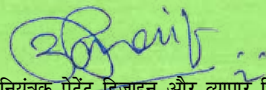
  
महानियंत्रक पेटेंट डिजाइन और व्यापार चिह्न  
Controller General of Patents, Designs and Trade Marks

पारस्परिकता तारीख (यदि कोई हो) जिसकी अनुमति देश के नाम पर की गई है। डिजाइन का सत्त्वाधिकार पंजीकरण की तारीख से दस वर्षों के लिए होगा जिसका विस्तार, अधिनियम एवं नियम के निबंधनों के अधीन, पाँच वर्षों की अतिरिक्त अवधि के लिए किया जा सकेगा। इस प्रमाण पत्र का उपयोग विधिक कार्यवाहियों अथवा विदेश में पंजीकरण प्राप्त करने के लिए नहीं हो सकता है।

\*The reciprocity date (if any) which has been allowed and the name of the country. Copyright in the design will subsist for ten years from the date of Registration, and may under the terms of the Act and Rules, be extended for a further period of five years. This Certificate is not for use in legal proceedings or for obtaining registration abroad.



ORIGINAL

मूल/No : 137966



भारत सरकार  
GOVERNMENT OF INDIA  
पेटेंट कार्यालय  
THE PATENT OFFICE

डिजाइन के पंजीकरण का प्रमाणपत्र  
CERTIFICATE OF REGISTRATION OF DESIGN

डिजाइन सं. / Design No. : 348486-001  
तारीख / Date : 27/08/2021  
पारस्परिकता तारीख / Reciprocity Date\* :  
देश / Country :

प्रमाणित किया जाता है कि संलग्न प्रति में वर्णित डिजाइन जो **LOFT BED** से संबंधित है, का पंजीकरण, श्रेणी **06-02** में 1.Centurion University Of Technology And Management 2. Tapan Kumar Padhy 3.Hariharan Nelli 4.Dinesh Tej Kovelakonda 5.Suman Kumar Sudhanshu के नाम में उपर्युक्त संख्या और तारीख में कर लिया गया है।

Certified that the design of which a copy is annexed hereto has been registered as of the number and date given above in class **06-02** in respect of the application of such design to **LOFT BED** in the name of 1.Centurion University Of Technology And Management 2. Tapan Kumar Padhy 3.Hariharan Nelli 4.Dinesh Tej Kovelakonda 5.Suman Kumar Sudhanshu.

डिजाइन अधिनियम, 2000 तथा डिजाइन नियम, 2001 के अध्याधीन प्रावधानों के अनुसरण में।

In pursuance of and subject to the provisions of the Designs Act, 2000 and the Designs Rules, 2001.

INTELLECTUAL  
PROPERTY INDIA  
PATENTS | DESIGNS | TRADE MARKS  
GEOGRAPHICAL INDICATIONS

निर्गमन की तारीख/Date of Issue : 25/05/2023

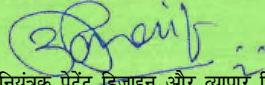
  
महानियंत्रक पेटेंट डिजाइन और व्यापार चिह्न  
Controller General of Patents, Designs and Trade Marks

पारस्परिकता तारीख (यदि कोई हो) जिसकी अनुमति देश के नाम पर की गई है। डिजाइन का सत्त्वाधिकार पंजीकरण की तारीख से दस वर्षों के लिए होगा जिसका विस्तार, अधिनियम एवं नियम के निबंधनों के अधीन, पाँच वर्षों की अतिरिक्त अवधि के लिए किया जा सकेगा। इस प्रमाण पत्र का उपयोग विधिक कार्यवाहियों अथवा विदेश में पंजीकरण प्राप्त करने के लिए नहीं हो सकता है।

\*The reciprocity date (if any) which has been allowed and the name of the country. Copyright in the design will subsist for ten years from the date of Registration, and may under the terms of the Act and Rules, be extended for a further period of five years. This Certificate is not for use in legal proceedings or for obtaining registration abroad.



ORIGINAL

मूल/No : 137213



भारत सरकार  
GOVERNMENT OF INDIA  
पेटेंट कार्यालय  
THE PATENT OFFICE

डिजाइन के पंजीकरण का प्रमाणपत्र  
CERTIFICATE OF REGISTRATION OF DESIGN

डिजाइन सं. / Design No. : 357338-001  
तारीख / Date : 26/01/2022  
पारस्परिकता तारीख / Reciprocity Date\* :  
देश / Country :

प्रमाणित किया जाता है कि संलग्न प्रति में वर्णित डिजाइन जो **E-GARBAGE DISPOSAL VAN** से संबंधित है, का पंजीकरण, श्रेणी **12-13** में 1.Centurion University Of Technology & Management (Cutm) 2. Avinash Kumar Singh 3.Mukundjee Pandey के नाम में उपर्युक्त संख्या और तारीख में कर लिया गया है।

Certified that the design of which a copy is annexed hereto has been registered as of the number and date given above in class **12-13** in respect of the application of such design to **E-GARBAGE DISPOSAL VAN** in the name of 1.Centurion University Of Technology & Management (Cutm) 2. Avinash Kumar Singh 3.Mukundjee Pandey.

डिजाइन अधिनियम, 2000 तथा डिजाइन नियम, 2001 के अध्याधीन प्रावधानों के अनुसरण में।

In pursuance of and subject to the provisions of the Designs Act, 2000 and the Designs Rules, 2001.

INTELLECTUAL  
PROPERTY INDIA  
PATENTS | DESIGNS | TRADE MARKS  
GEOGRAPHICAL INDICATIONS

निर्गमन की तारीख/Date of Issue : 23/05/2023

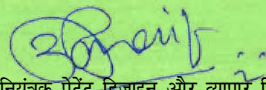
  
महानियंत्रक पेटेंट डिजाइन और व्यापार चिह्न  
Controller General of Patents, Designs and Trade Marks

पारस्परिकता तारीख (यदि कोई हो) जिसकी अनुमति देश के नाम पर की गई है। डिजाइन का सत्त्वाधिकार पंजीकरण की तारीख से दस वर्षों के लिए होगा जिसका विस्तार, अधिनियम एवं नियम के निबंधनों के अधीन, पाँच वर्षों की अतिरिक्त अवधि के लिए किया जा सकेगा। इस प्रमाण पत्र का उपयोग विधिक कार्यवाहियों अथवा विदेश में पंजीकरण प्राप्त करने के लिए नहीं हो सकता है।

\*The reciprocity date (if any) which has been allowed and the name of the country. Copyright in the design will subsist for ten years from the date of Registration, and may under the terms of the Act and Rules, be extended for a further period of five years. This Certificate is not for use in legal proceedings or for obtaining registration abroad.



ORIGINAL

मूल/No : 135884



भारत सरकार  
GOVERNMENT OF INDIA  
पेटेंट कार्यालय  
THE PATENT OFFICE

डिजाइन के पंजीकरण का प्रमाणपत्र  
CERTIFICATE OF REGISTRATION OF DESIGN

डिजाइन सं. / Design No. : 379893-001  
तारीख / Date : 22/02/2023  
पारस्परिकता तारीख / Reciprocity Date\* :  
देश / Country :

प्रमाणित किया जाता है कि संलग्न प्रति में वर्णित डिजाइन जो **RENEWABLE ENERGY POWERED POLES TO DETECT NOISE POLLUTION** से संबंधित है, का पंजीकरण, श्रेणी 10-05 में 1.Dr.Saine Sikta Dash 2. Dr.Sasmita Behera 3.Prof.Saswat Mishra 4.Dr.Siba Prasad Mishra 5.Prof. Deepak Kumar Sahu 6.Dr.Jyoti Prakash Giri 7.Dr.Prangya Parimita Pradhan 8.Prof.Priyanka Mishra 9.Prof.Nimay Chandra Giri के नाम में उपर्युक्त संख्या और तारीख में कर लिया गया है।

Certified that the design of which a copy is annexed hereto has been registered as of the number and date given above in class **10-05** in respect of the application of such design to **RENEWABLE ENERGY POWERED POLES TO DETECT NOISE POLLUTION** in the name of 1.Dr.Saine Sikta Dash 2. Dr.Sasmita Behera 3.Prof.Saswat Mishra 4.Dr.Siba Prasad Mishra 5.Prof. Deepak Kumar Sahu 6.Dr.Jyoti Prakash Giri 7.Dr.Prangya Parimita Pradhan 8.Prof.Priyanka Mishra 9.Prof.Nimay Chandra Giri.

डिजाइन अधिनियम, 2000 तथा डिजाइन नियम, 2001 के अध्याधीन प्रावधानों के अनुसरण में।

In pursuance of and subject to the provisions of the Designs Act, 2000 and the Designs Rules, 2001.

INTELLECTUAL  
PROPERTY INDIA  
PATENTS | DESIGNS | TRADE MARKS  
GEOGRAPHICAL INDICATIONS

निर्गमन की तारीख/Date of Issue : 17/05/2023

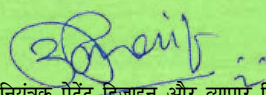
  
महानियंत्रक पेटेंट डिजाइन और व्यापार चिह्न  
Controller General of Patents, Designs and Trade Marks

पारस्परिकता तारीख (यदि कोई हो) जिसकी अनुमति देश के नाम पर की गई है। डिजाइन का सत्त्वाधिकार पंजीकरण की तारीख से दस वर्षों के लिए होगा जिसका विस्तार, अधिनियम एवं नियम के निबंधनों के अधीन, पाँच वर्षों की अतिरिक्त अवधि के लिए किया जा सकेगा। इस प्रमाण पत्र का उपयोग विधिक कार्यवाहियों अथवा विदेश में पंजीकरण प्राप्त करने के लिए नहीं हो सकता है।

\*The reciprocity date (if any) which has been allowed and the name of the country. Copyright in the design will subsist for ten years from the date of Registration, and may under the terms of the Act and Rules, be extended for a further period of five years. This Certificate is not for use in legal proceedings or for obtaining registration abroad.



ORIGINAL

मूल/No : 136484



भारत सरकार  
GOVERNMENT OF INDIA  
पेटेंट कार्यालय  
THE PATENT OFFICE

डिजाइन के पंजीकरण का प्रमाणपत्र  
CERTIFICATE OF REGISTRATION OF DESIGN

डिजाइन सं. / Design No. : 380508-001  
तारीख / Date : 01/03/2023  
पारस्परिकता तारीख / Reciprocity Date\* :  
देश / Country :

प्रमाणित किया जाता है कि संलग्न प्रति में वर्णित डिजाइन जो **SOLAR BIOMASS INTEGRATED CROP DRYER** से संबंधित है, का पंजीकरण, श्रेणी **15-03** में 1.Prof. Poulomi Chatterjee 2. Prof. Amit Kumar 3.Prof. Susovan Dutta 4.Dr. Susmita Das 5.Ar. Teesha Majumder 6.Dr. Sanjeeta Biswas 7.Dr. Devegowda S R 8.Prof. Prasheet Mishra 9.Dr.Nimay Chandra Giri के नाम में उपर्युक्त संख्या और तारीख में कर लिया गया है।

Certified that the design of which a copy is annexed hereto has been registered as of the number and date given above in class **15-03** in respect of the application of such design to **SOLAR BIOMASS INTEGRATED CROP DRYER** in the name of 1.Prof. Poulomi Chatterjee 2. Prof. Amit Kumar 3.Prof. Susovan Dutta 4.Dr. Susmita Das 5.Ar. Teesha Majumder 6.Dr. Sanjeeta Biswas 7.Dr. Devegowda S R 8.Prof. Prasheet Mishra 9.Dr.Nimay Chandra Giri.

डिजाइन अधिनियम, 2000 तथा डिजाइन नियम, 2001 के अध्याधीन प्रावधानों के अनुसरण में।

In pursuance of and subject to the provisions of the Designs Act, 2000 and the Designs Rules, 2001.

INTELLECTUAL  
PROPERTY INDIA  
PATENTS | DESIGNS | TRADE MARKS  
GEOGRAPHICAL INDICATIONS

निर्गमन की तारीख/Date of Issue : 18/05/2023

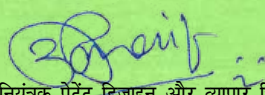
  
महानियंत्रक पेटेंट डिजाइन और व्यापार चिह्न  
Controller General of Patents, Designs and Trade Marks

पारस्परिकता तारीख (यदि कोई हो) जिसकी अनुमति देश के नाम पर की गई है। डिजाइन का सत्त्वाधिकार पंजीकरण की तारीख से दस वर्षों के लिए होगा जिसका विस्तार, अधिनियम एवं नियम के निबंधनों के अधीन, पाँच वर्षों की अतिरिक्त अवधि के लिए किया जा सकेगा। इस प्रमाण पत्र का उपयोग विधिक कार्यवाहियों अथवा विदेश में पंजीकरण प्राप्त करने के लिए नहीं हो सकता है।

\*The reciprocity date (if any) which has been allowed and the name of the country. Copyright in the design will subsist for ten years from the date of Registration, and may under the terms of the Act and Rules, be extended for a further period of five years. This Certificate is not for use in legal proceedings or for obtaining registration abroad.





ORIGINAL

मूल/No : 138096



भारत सरकार  
GOVERNMENT OF INDIA  
पेटेंट कार्यालय  
THE PATENT OFFICE

डिजाइन के पंजीकरण का प्रमाणपत्र  
CERTIFICATE OF REGISTRATION OF DESIGN

डिजाइन सं. / Design No. : 380801-001  
तारीख / Date : 04/03/2023  
पारस्परिकता तारीख / Reciprocity Date\* :  
देश / Country :

प्रमाणित किया जाता है कि संलग्न प्रति में वर्णित डिजाइन जो **FLOATING SOLAR PHOTOVOLTAIC CELL** से संबंधित है, का पंजीकरण, श्रेणी **13-04** में 1.Prof.Poulomi Chatterjee 2. Prof.Amit Kumar 3.Prof.Debasis Chatterjee 4.Prof.Susovan Dutta 5.Dr.Alivarani Mohapatra 6.Dr.Debani Prasad Mishra 7.Dr.Siba Prasad Mishra 8.Dr.Prangya Parimita Pradhan 9.Dr.Nimay Chandra Giri के नाम में उपर्युक्त संख्या और तारीख में कर लिया गया है।

Certified that the design of which a copy is annexed hereto has been registered as of the number and date given above in class **13-04** in respect of the application of such design to **FLOATING SOLAR PHOTOVOLTAIC CELL** in the name of 1.Prof.Poulomi Chatterjee 2. Prof.Amit Kumar 3.Prof.Debasis Chatterjee 4.Prof.Susovan Dutta 5.Dr.Alivarani Mohapatra 6.Dr.Debani Prasad Mishra 7.Dr.Siba Prasad Mishra 8.Dr.Prangya Parimita Pradhan 9.Dr.Nimay Chandra Giri.

डिजाइन अधिनियम, 2000 तथा डिजाइन नियम, 2001 के अध्याधीन प्रावधानों के अनुसरण में।

In pursuance of and subject to the provisions of the Designs Act, 2000 and the Designs Rules, 2001.

INTELLECTUAL  
PROPERTY INDIA  
PATENTS | DESIGNS | TRADE MARKS  
GEOGRAPHICAL INDICATIONS

निर्गमन की तारीख/Date of Issue : 25/05/2023

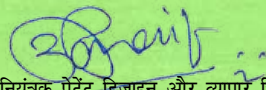
  
महानियंत्रक पेटेंट डिजाइन और व्यापार चिह्न  
Controller General of Patents, Designs and Trade Marks

पारस्परिकता तारीख (यदि कोई हो) जिसकी अनुमति देश के नाम पर की गई है। डिजाइन का सत्त्वाधिकार पंजीकरण की तारीख से दस वर्षों के लिए होगा जिसका विस्तार, अधिनियम एवं नियम के निबंधनों के अधीन, पाँच वर्षों की अतिरिक्त अवधि के लिए किया जा सकेगा। इस प्रमाण पत्र का उपयोग विधिक कार्यवाहियों अथवा विदेश में पंजीकरण प्राप्त करने के लिए नहीं हो सकता है।

\*The reciprocity date (if any) which has been allowed and the name of the country. Copyright in the design will subsist for ten years from the date of Registration, and may under the terms of the Act and Rules, be extended for a further period of five years. This Certificate is not for use in legal proceedings or for obtaining registration abroad.



ORIGINAL

मूल/No : 137345



भारत सरकार  
GOVERNMENT OF INDIA  
पेटेंट कार्यालय  
THE PATENT OFFICE

डिजाइन के पंजीकरण का प्रमाणपत्र  
CERTIFICATE OF REGISTRATION OF DESIGN

डिजाइन सं. / Design No. : 352888-001  
तारीख / Date : 10/11/2021  
पारस्परिकता तारीख / Reciprocity Date\* :  
देश / Country :

प्रमाणित किया जाता है कि संलग्न प्रति में वर्णित डिजाइन जो **A MEDICAL NEEDLE STERILIZATION BOX** से संबंधित है, का पंजीकरण, श्रेणी **24-02** में 1.Dr. Ranjan Kumar Mohapatra 2. Dr.Ashish Kumar Sarangi 3.Dr.Pranab Kishor Mohapatra 4.Dr.Alok Ranjan Sahu के नाम में उपर्युक्त संख्या और तारीख में कर लिया गया है।

Certified that the design of which a copy is annexed hereto has been registered as of the number and date given above in class **24-02** in respect of the application of such design to **A MEDICAL NEEDLE STERILIZATION BOX** in the name of 1.Dr. Ranjan Kumar Mohapatra 2. Dr.Ashish Kumar Sarangi 3.Dr.Pranab Kishor Mohapatra 4.Dr.Alok Ranjan Sahu.

डिजाइन अधिनियम, 2000 तथा डिजाइन नियम, 2001 के अध्याधीन प्रावधानों के अनुसरण में।

In pursuance of and subject to the provisions of the Designs Act, 2000 and the Designs Rules, 2001.

INTELLECTUAL  
PROPERTY INDIA  
PATENTS | DESIGNS | TRADE MARKS  
GEOGRAPHICAL INDICATIONS

निर्गमन की तारीख/Date of Issue : 23/05/2023

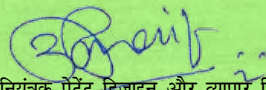
  
महानियंत्रक पेटेंट डिजाइन और व्यापार चिह्न  
Controller General of Patents, Designs and Trade Marks

पारस्परिकता तारीख (यदि कोई हो) जिसकी अनुमति देश के नाम पर की गई है। डिजाइन का सत्त्वाधिकार पंजीकरण की तारीख से दस वर्षों के लिए होगा जिसका विस्तार, अधिनियम एवं नियम के निबंधनों के अधीन, पाँच वर्षों की अतिरिक्त अवधि के लिए किया जा सकेगा। इस प्रमाण पत्र का उपयोग विधिक कार्यवाहियों अथवा विदेश में पंजीकरण प्राप्त करने के लिए नहीं हो सकता है।

\*The reciprocity date (if any) which has been allowed and the name of the country. Copyright in the design will subsist for ten years from the date of Registration, and may under the terms of the Act and Rules, be extended for a further period of five years. This Certificate is not for use in legal proceedings or for obtaining registration abroad.

ORIGINAL

क्रम सं/ Serial No. : 139064



INTELLECTUAL PROPERTY INDIA PATENTS | DESIGNS | TRADE MARKS | GEOGRAPHICAL INDICATIONS

सत्यमेव जयते

पेटेंट कार्यालय, भारत सरकार

The Patent Office, Government Of India

डिजाइन के पंजीकरण का प्रमाण पत्र

Certificate of Registration of Design

डिजाइन सं. / Design No. : 348488-001

तारीख / Date : 27/08/2021

पारस्परिकता तारीख / Reciprocity Date\* :

देश / Country :

प्रमाणित किया जाता है कि संलग्न प्रति में वर्णित डिजाइन जो SOFA SET से संबंधित है, का पंजीकरण, श्रेणी 06-01 में 1.Centurion University Of Technology And Management 2. Tapan Kumar Padhy 3.Hariharan Nelli 4.Dinesh Tej Kovelakonda 5.Suman Kumar Sudhanshu के नाम में उपर्युक्त संख्या और तारीख में कर लिया गया है।

Certified that the design of which a copy is annexed hereto has been registered as of the number and date given above in class 06-01 in respect of the application of such design to SOFA SET in the name of 1.Centurion University Of Technology And Management 2. Tapan Kumar Padhy 3.Hariharan Nelli 4.Dinesh Tej Kovelakonda 5.Suman Kumar Sudhanshu.

डिजाइन अधिनियम, 2000 तथा डिजाइन नियम, 2001 के अधधीन प्रावधानों के अनुसरण में। In pursuance of and subject to the provisions of the Designs Act, 2000 and the Designs Rules, 2001.

जारी करने की तिथि : 07/06/2023 Date of Issue



महानियंत्रक पेटेंट, डिजाइन और व्यापार चिह्न

Controller General of Patents, Designs and Trade Marks

\*पारस्परिकता तारीख (यदि कोई हो) जिसकी अनुमति दी गई है तथा देश का नाम। डिजाइन का स्वत्वाधिकार पंजीकरण की तारीख से दस वर्षों के लिए होगा जिसका विस्तार, अधिनियम एवं नियम के निबंधनों के अधीन, पाँच वर्षों की अतिरिक्त अवधि के लिए किया जा सकेगा। इस प्रमाण पत्र का उपयोग विधिक कार्यवाहियों अथवा विदेश में पंजीकरण प्राप्त करने के लिए नहीं हो सकता है।

The reciprocity date (if any) which has been allowed and the name of the country. Copyright in the design will subsist for ten years from the date of Registration, and may under the terms of the Act and Rules, be extended for a further period of five years. This Certificate is not for use in legal proceedings or for obtaining registration abroad.



Intellectual  
Property  
Office

# Certificate of Registration for a UK Design

Design number: 6285107

Grant date: 09 June 2023

Registration date: 24 May 2023

## This is to certify that,

in pursuance of and subject to the provision of Registered Designs Act 1949, the design of which a representation or specimen is attached, had been registered as of the date of registration shown above in the name of

Dr. Ashok Misra, Dr. Banitamani Mallik, Ms. Nagalapalli Jeebaratnam, Ms.

Gedala Sridevi, Dr. Sujit Mishra, Mr. Debarghya De, Ms. Priya Khanda

in respect of the application of such design to:

Water quality prediction device

International Design Classification:

Version: 14-2023

Class: 10 CLOCKS AND WATCHES AND OTHER MEASURING  
INSTRUMENTS, CHECKING AND SIGNALLING INSTRUMENTS

Subclass: 05 INSTRUMENTS, APPARATUS AND DEVICES FOR CHECKING,  
SECURITY OR TESTING

## Adam Williams

Comptroller-General of Patents, Designs and Trade Marks

Intellectual Property Office

The attention of the Proprietor(s) is drawn to the important notes overleaf.



**Representation of Designs**









Intellectual Property Office is an operating name of the Patent Office

[www.gov.uk/ipo](http://www.gov.uk/ipo)





## Design details

**Design application number**  
6285107

**Filing date (provisional)**  
24 May 2023

**Defer registration**  
No

**Design**  
Water quality prediction device

**Additional description**  
Water quality prediction device

**Illustration disclaimer**  
No claim is made to the colour shown in the drawings

## Illustrations

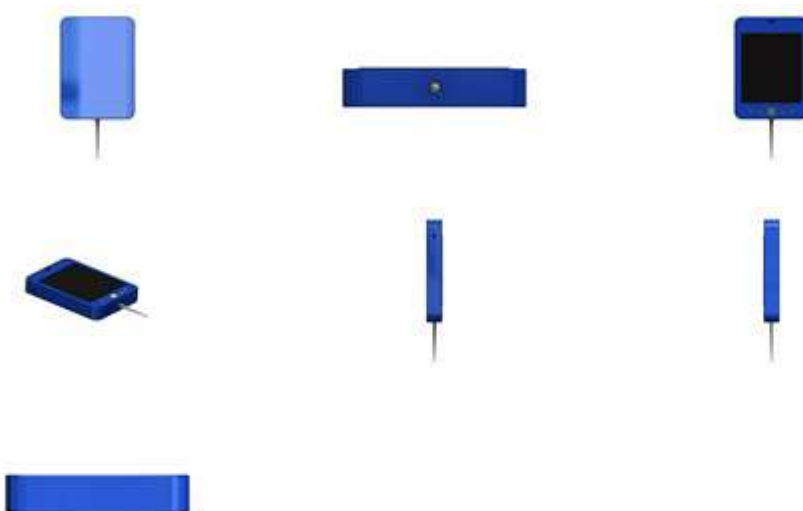

**Repeated surface pattern**  
No

## Priority claims

None

## Owner details

### **Dr. Ashok Misra**

Professor, Department of Mathematics, Centurion University of Technology and Management, Paralakhemundi, Aluri Nagar, R.Sithapur, Upalada, Gajapati, Odisha, 761211, India

### **Dr. Banitamani Mallik**

Professor, Department of Mathematics, Centurion University of Technology and Management, Paralakhemundi, Aluri Nagar, R.Sithapur, Upalada, Gajapati, Odisha, 761211, India

### **Ms. N Jeebaratnam**

Assistant Professor, Department of ECE, Centurion University of Technology and Management, Paralakhemundi, Aluri Nagar, R.Sithapur, Upalada, Gajapati, Odisha, 761211, India

### **Ms. G Sreedevi**

Assistant Professor, Department of ME, Centurion University of Technology and Management, Paralakhemundi, Aluri Nagar, R.Sithapur, Upalada, Gajapati, Odisha, 761211, India

### **Dr. Sujit Mishra**

Assistant Professor, Department of ME, Centurion University of Technology and Management, Paralakhemundi, Aluri Nagar, R.Sithapur, Upalada, Gajapati, Odisha, 761211, India

### **Mr. Debarghya De**

Student, Department of Agriculture Engineering, Centurion University of Technology and Management, Paralakhemundi, Aluri Nagar, R.Sithapur, Upalada, Gajapati, Odisha, 761211, India

### **Ms. Priya Khanda**

Student, Department of Agriculture Engineering, Centurion University of Technology and Management, Paralakhemundi, Aluri Nagar, R.Sithapur, Upalada, Gajapati, Odisha, 761211, India

## Contact details



Reference: LXG 3994

**Please note this is an uncertified copy of your registration document which you can use for research or personal use.**

## Design Application Details

<b>Application Number:</b>	381334-001
<b>Cbr Number:</b>	203171
<b>Cbr Date:</b>	12/03/2023 13:51:11
<b>Applicant Name:</b>	<ol style="list-style-type: none"><li>1. Dr. Dharmendra Ahuja</li><li>2. Hemlata Rathore</li><li>3. Ankit Kumar</li><li>4. Shmriti</li><li>5. Dr. Nihar Ranjan Kar</li><li>6. Ms. Linda Xavier</li><li>7. Mr. Abhijit Gupta</li></ol>

## Design Application Status

**Application Status:** Design Accepted and Published, Journal No is 22/2023 and Journal Date is 02/06/2023

[Back](#)

<b>Design Number</b>	381334-001	
<b>Class</b>	10-05	
<b>1. Dr. Dharmendra Ahuja</b> Dean, Faculty of Pharmaceutical Science, Jayoti Vidyapeeth Women's University, Jaipur, Rajasthan, India 303122. <b>2. Hemlata Rathore</b> Assistant Professor, Department of Pharmacognosy, School of Pharmacy Chouksey Engineering College Bilaspur, Chhattisgarh-495004, India. <b>3. Ankit Kumar</b> Assistant Professor, Department of Paramedical Sciences, Subharti Medical College, Swami Vivekanand Subharti University, Meerut, Uttar Pradesh-250005, India. <b>4. Shmriti</b> Assistant Professor, Department of Paramedical Sciences, Subharti Medical College, Swami Vivekanand Subharti University, Meerut, Uttar Pradesh-250005, India. , et al.		
<b>Date of Registration</b>	12/03/2023	
<b>Title</b>	TRANSDERMAL ALCOHOL MONITORING DEVICE	
<b>Priority NA</b>		



INTELLECTUAL PROPERTY INDIA PATENTS | DESIGNS | TRADE MARKS | GEOGRAPHICAL INDICATIONS



सत्यमेव जयते

पेटेंट कार्यालय, भारत सरकार

The Patent Office, Government Of India

डिजाइन के पंजीकरण का प्रमाण पत्र

Certificate of Registration of Design

डिजाइन सं. / Design No. : 381334-001
तारीख / Date : 12/03/2023
पारस्परिकता तारीख / Reciprocity Date\* :
देश / Country :

प्रमाणित किया जाता है कि संलग्न प्रति में वर्णित डिजाइन जो TRANSDERMAL ALCOHOL MONITORING DEVICE से संबंधित है, का पंजीकरण, श्रेणी 10-05 में 1.Dr. Dharmendra Ahuja 2. Hemlata Rathore 3.Ankit Kumar 4.Shmriti 5.Dr. Nihar Ranjan Kar 6.Ms. Linda Xavier 7.Mr. Abhijit Gupta के नाम में उपर्युक्त संख्या और तारीख में कर लिया गया है।

Certified that the design of which a copy is annexed hereto has been registered as of the number and date given above in class 10-05 in respect of the application of such design to TRANSDERMAL ALCOHOL MONITORING DEVICE in the name of 1.Dr. Dharmendra Ahuja 2. Hemlata Rathore 3.Ankit Kumar 4.Shmriti 5.Dr. Nihar Ranjan Kar 6.Ms. Linda Xavier 7.Mr. Abhijit Gupta.

डिजाइन अधिनियम, 2000 तथा डिजाइन नियम, 2001 के अधधीन प्रावधानों के अनुसरण में।

In pursuance of and subject to the provisions of the Designs Act, 2000 and the Designs Rules, 2001.

जारी करने की तिथि : 01/06/2023
Date of Issue



Handwritten signature of the Controller General of Patents, Designs and Trade Marks

महानियंत्रक पेटेंट, डिजाइन और व्यापार चिह्न
Controller General of Patents, Designs and Trade Marks

\*पारस्परिकता तारीख (यदि कोई हो) जिसकी अनुमति दी गई है तथा देश का नाम। डिजाइन का स्वत्वाधिकार पंजीकरण की तारीख से दस वर्षों के लिए होगा जिसका विस्तार, अधिनियम एवं नियम के निबंधनों के अधीन, पाँच वर्षों की अतिरिक्त अवधि के लिए किया जा सकेगा। इस प्रमाण पत्र का उपयोग विधिक कार्यवाहियों अथवा विदेश में पंजीकरण प्राप्त करने के लिए नहीं हो सकता है।

The reciprocity date (if any) which has been allowed and the name of the country. Copyright in the design will subsist for ten years from the date of Registration, and may under the terms of the Act and Rules, be extended for a further period of five years. This Certificate is not for use in legal proceedings or for obtaining registration abroad.



Intellectual  
Property  
Office

# Certificate of Registration for a UK Design

Design number: 6264907

Grant date: 07 March 2023

Registration date: 28 February 2023

## This is to certify that,

in pursuance of and subject to the provision of Registered Designs Act 1949, the design of which a representation or specimen is attached, had been registered as of the date of registration shown above in the name of

Mr. Brijesh Kumar Saroj, Mr. Mohammad Muztaba, Ms. Sarita Verma, Dr. R.

Rajagopalan, Dr. Farhad F Mehta, Dr. Bhuwanendra Singh , Mrs. Mughisa

Nagori, Dr. Akhilesh Patel, Mr. Mohammad Haneef, Dr. Nihar Ranjan Kar

in respect of the application of such design to:

GLASS APPARATUS FOR SEPARATING PARTICLES FROM

PHARMACEUTICAL NANOSUSPENSION

International Design Classification:

Version: 14-2023

Class: 24 MEDICAL AND LABORATORY EQUIPMENT

Subclass: 02 MEDICAL INSTRUMENTS, INSTRUMENTS AND TOOLS FOR LABORATORY USE

**Adam Williams**

Comptroller-General of Patents, Designs and Trade Marks  
Intellectual Property Office

The attention of the Proprietor(s) is drawn to the important notes overleaf.



Representation of Designs

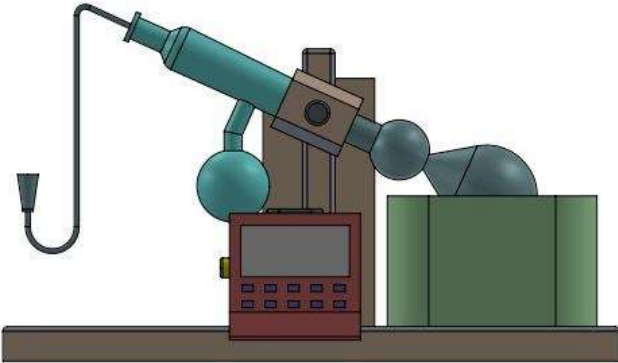
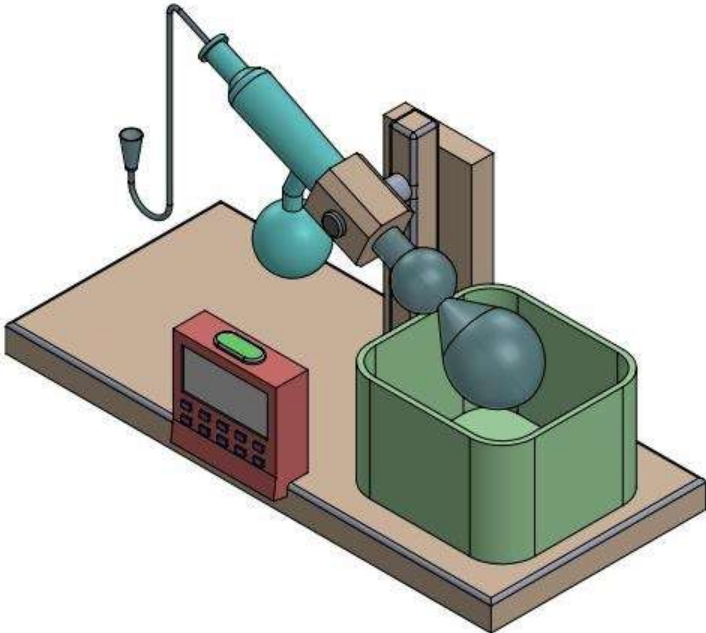

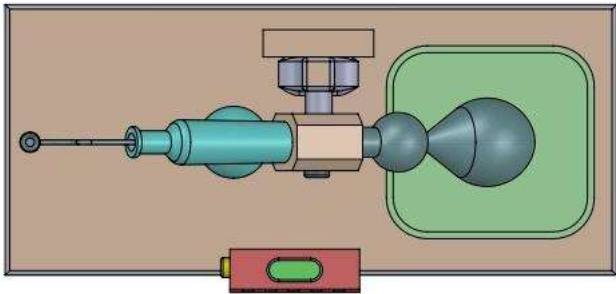
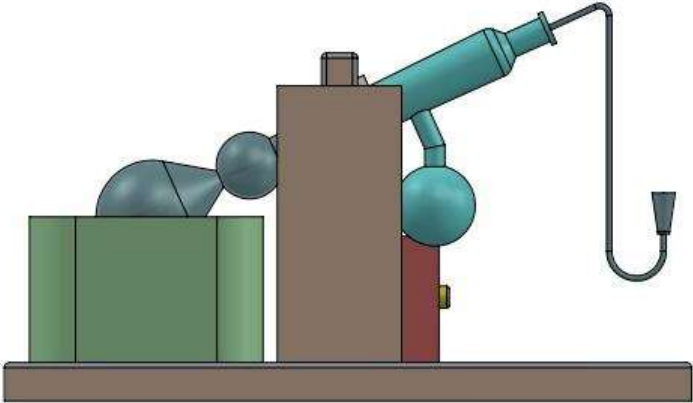

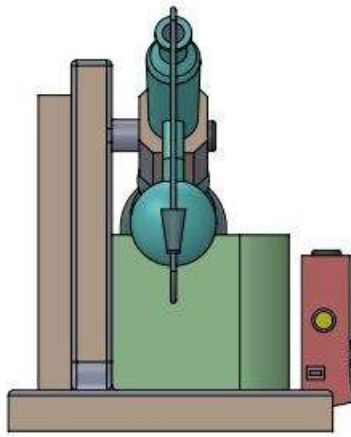
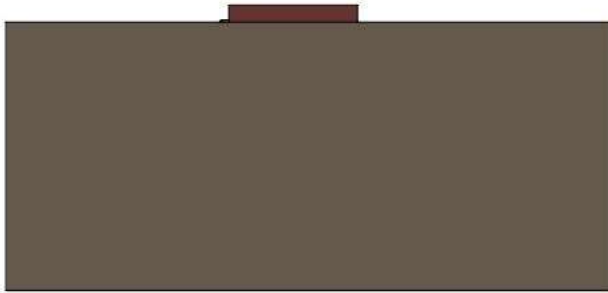



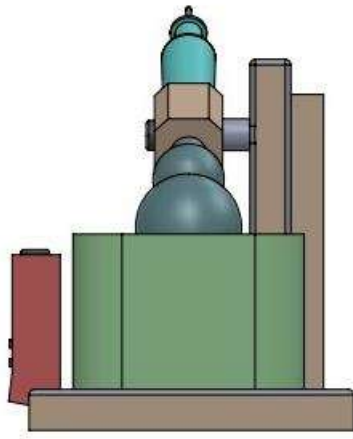

Intellectual Property Office is an operating name of the Patent Office

[www.gov.uk/ipo](http://www.gov.uk/ipo)



ORIGINAL  
क्रम सं/ Serial No. : 140189



पेटेंट कार्यालय, भारत सरकार

The Patent Office, Government Of India

डिजाइन के पंजीकरण का प्रमाण पत्र

Certificate of Registration of Design

डिजाइन सं. / Design No. 382767-001

तारीख / Date 03/04/2023

पारस्परिकता तारीख / Reciprocity Date

देश / Country

प्रमाणित किया जाता है कि संलग्न प्रति में वर्णित डिजाइन जो **WASTEWATER TREATMENT DEVICE** से संबंधित है, का पंजीकरण, श्रेणी 23-01 में 1.Dr. Prafulla Kumar Panda 2. Dr. Rajib Kumar Majhi 3.Krushna Chandra Sethi 4.Mr. B. Bikram Narayan 5.Subhadarshani Satapathy 6.Dillip Kumar Baral के नाम में उपर्युक्त संख्या और तारीख में कर लिया गया है।

Certified that the design of which a copy is annexed hereto has been registered as of the number and date given above in class 23-01 in respect of the application of such design to **WASTEWATER TREATMENT DEVICE** in the name of 1.Dr. Prafulla Kumar Panda 2. Dr. Rajib Kumar Majhi 3.Krushna Chandra Sethi 4.Mr. B. Bikram Narayan 5.Subhadarshani Satapathy 6.Dillip Kumar Baral.

डिजाइन अधिनियम, 2000 तथा डिजाइन नियम, 2001 के अधधीन प्रावधानों के अनुसरण में।

In pursuance of and subject to the provisions of the Designs Act, 2000 and the Designs Rules, 2001.

जारी करने की तिथि : 06/07/2023  
Date of Issue



*(Signature)*

महानियंत्रक पेटेंट, डिजाइन और व्यापार चिह्न  
Controller General of Patents, Designs and Trade Marks

\*पारस्परिकता तारीख (यदि कोई हो) जिसकी अनुमति दी गई है तथा देश का नाम। डिजाइन का स्वत्वाधिकार पंजीकरण की तारीख से दस वर्षों के लिए होगा जिसका विस्तार, अधिनियम एवं नियम के निबंधनों के अधीन, पांच वर्षों की अतिरिक्त अवधि के लिए किया जा सकेगा। इस प्रमाण पत्र का उपयोग विधिक कार्यवाहियों अथवा विदेश में पंजीकरण प्राप्त करने के लिए नहीं हो सकता है।  
The reciprocity date (if any) which has been allowed and the name of the country. Copyright in the design will subsist for ten years from the date of Registration, and may under the terms of the Act and Rules, be extended for a further period of five years. This Certificate is not for use in legal proceedings or for obtaining registration abroad.



Intellectual  
Property  
Office

# Certificate of Registration for a UK Design

Design number: 6297798

Grant date: 31 July 2023

Registration date: 20 July 2023

## This is to certify that,

in pursuance of and subject to the provision of Registered Designs Act 1949, the design of which a representation or specimen is attached, had been registered as of the date of registration shown above in the name of

Dr. Shanmugarathinam Alagarsamy, Dr. Mohammad Ali, Dr. Nihar Ranjan Kar,

Mr. Mehul Batukbhai Vyas, Mr. Mineshkumar Ashvinkumar Patel, Dr. Ujwala

Sandip Dube, Dr. Rahil Bhura, Dr. Rinchi Bora, Dr. Sorabh Kumar Agrawal

in respect of the application of such design to:

Smart Dissolution Apparatus for Tablets & Capsules

International Design Classification:

Version: 14-2023

Class: 24 MEDICAL AND LABORATORY EQUIPMENT

Subclass: 01 APPARATUS AND EQUIPMENT FOR DOCTORS, HOSPITALS  
AND LABORATORIES

**Adam Williams**

Comptroller-General of Patents, Designs and Trade Marks

Intellectual Property Office

The attention of the Proprietor(s) is drawn to the important notes overleaf.



Representation of Designs

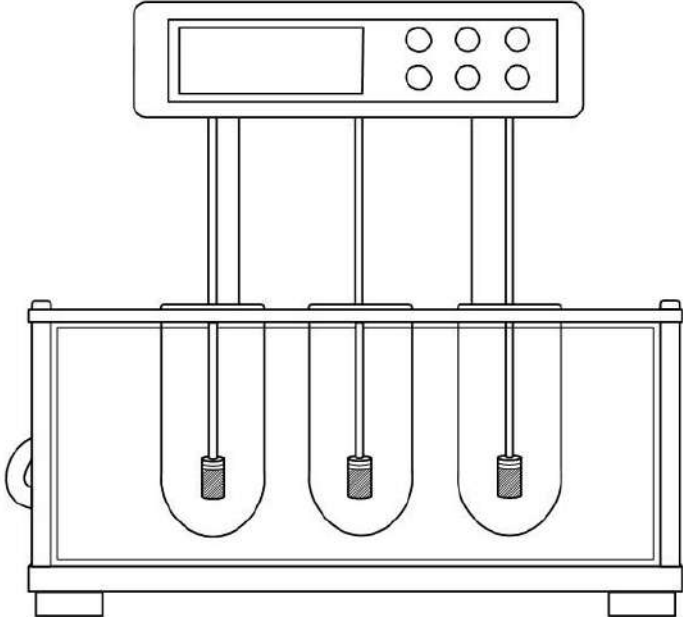
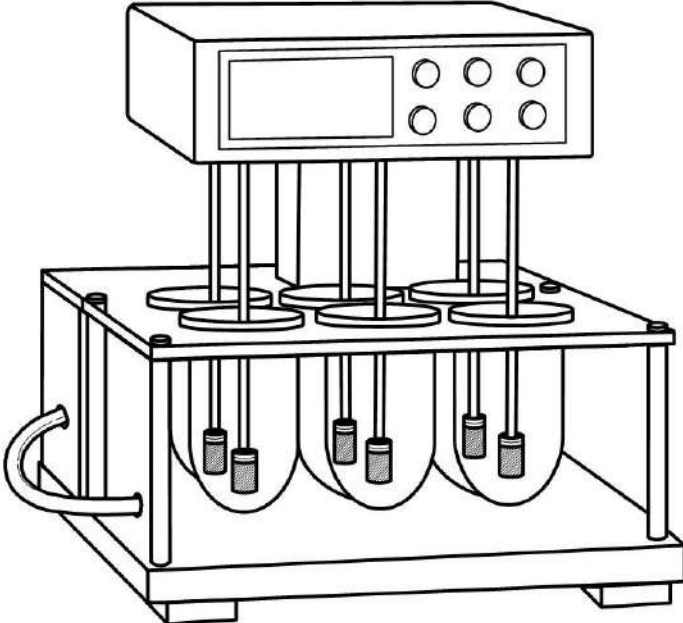

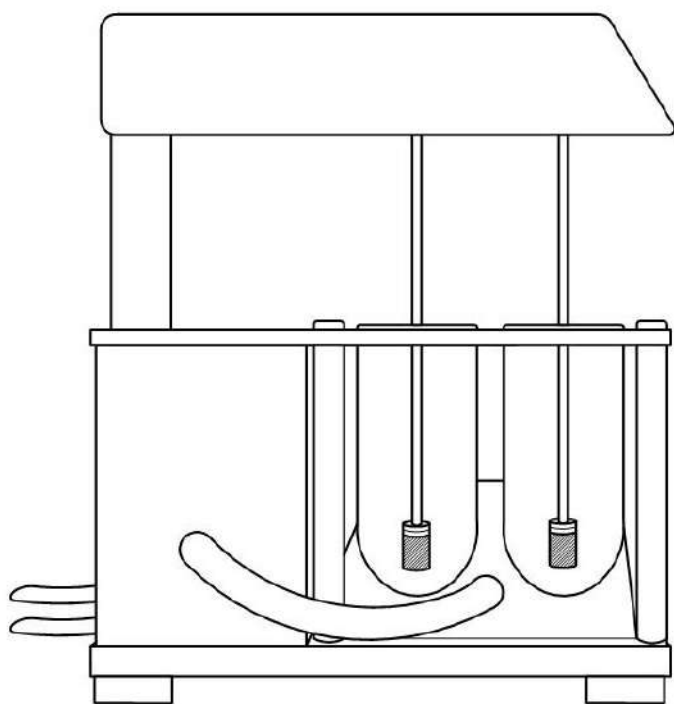
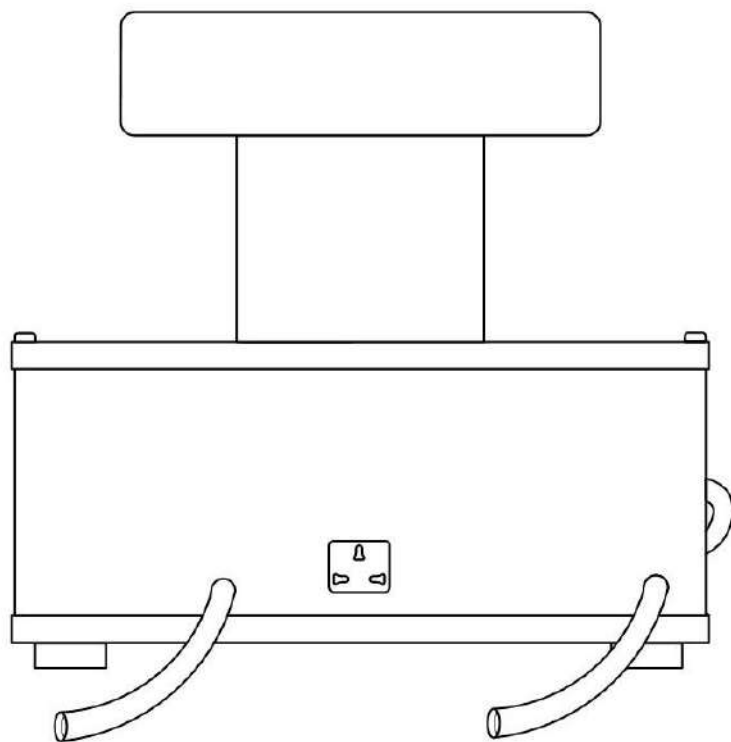

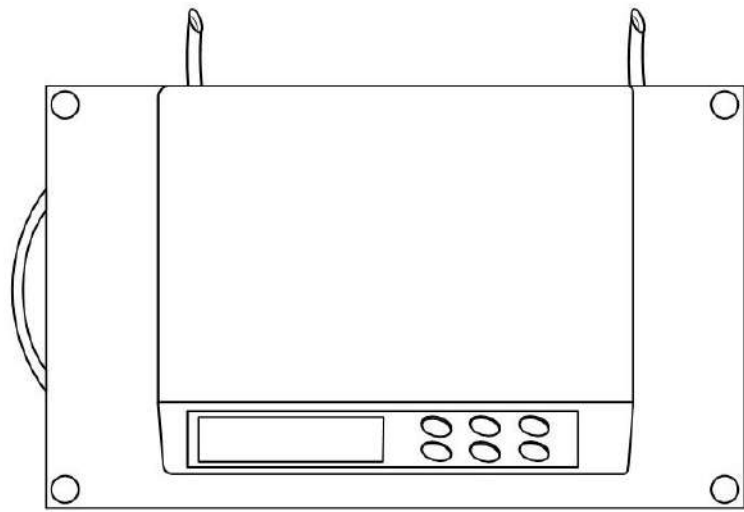
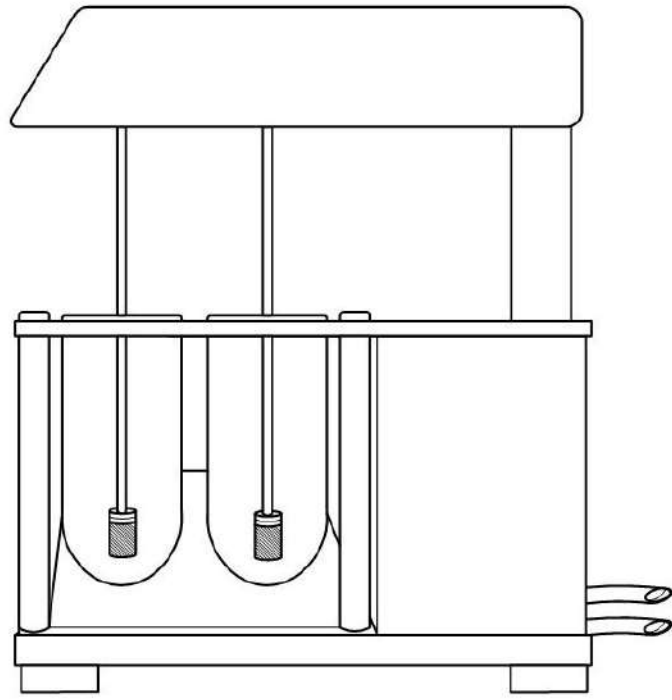

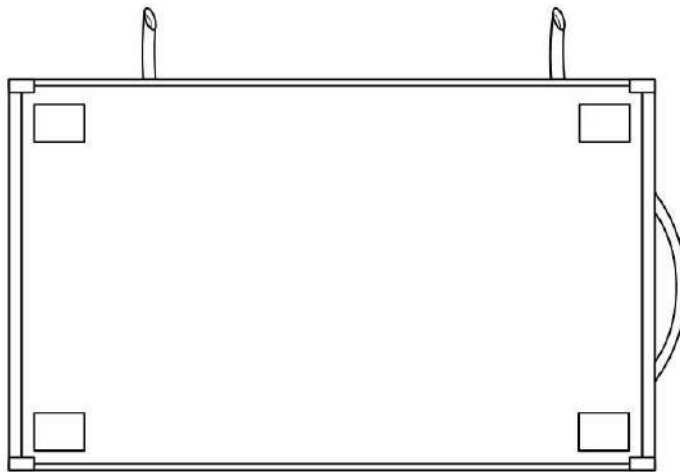

Intellectual Property Office is an operating name of the Patent Office

[www.gov.uk/ipo](http://www.gov.uk/ipo)

पेटेंट कार्यालय  
शासकीय जर्नल

**OFFICIAL JOURNAL  
OF  
THE PATENT OFFICE**

---

---

निर्गमन सं. 27/2023  
ISSUE NO. 27/2023

शुक्रवार  
**FRIDAY**

दिनांक: 07/07/2023  
DATE: 07/07/2023

---

---

पेटेंट कार्यालय का एक प्रकाशन  
PUBLICATION OF THE PATENT OFFICE



**INTRODUCTION**

In view of the recent amendment made in the Designs (Amendment) Rules, 2008 with effect from 17/06/2008, Publication of the matter relating to Designs is being published in the Official Journal of The Patent Office. This Journal is being published on weekly basis on every Friday covering the various proceedings on Designs as required according to the provisions of under Rule 22, 25, 27 and 39 of the Design (Amendment) Rules, 2008. All the enquiries on this Official Journal and other information as required by the public should be addressed to the Controller General of Patents, Designs & Trade Marks. Suggestions and comments are requested from all quarters so that the content can be enriched.

## Design Application Details

**Application Number:** 382987-001  
**Cbr Number:** 204220  
**Cbr Date:** 04/04/2023 17:21:59  
**Applicant Name:**  
1. Mr. Arun Kumar  
2. Mr. Afaque Raza Mehboob Ansari  
3. Mr. Mohit Chadha  
4. Dr. Mohammed Altaf Ahmed  
5. Dr. Nihar Ranjan Kar  
6. Dr. Shashank Soni  
7. Mrs. Ketaki Suhas Shinde  
8. Dr. Mohd Tanveer Khan  
9. Dr. Kritika Suresh Garg  
10. Mrs. Shruti Srivastava

## Design Application Status

**Application Status:** Design Accepted and Published, Journal No is 27/2023 and Journal Date is 07/07/2023

[Back](#)

<b>Design Number</b>	<b>382987-001</b>
<b>Class</b>	15-99
<b>Date of Registration</b>	04/04/2023
<b>Title</b>	Fluid bed granulator and bed dryer machine for pharmaceutical purpose
<b>Priority NA</b>	
<b>1.Mr. Arun Kumar Assistant Professor, Arya College of Pharmacy, Nawabganj, Bareilly, Uttar Pradesh - 262001 2. Mr. Afaque Raza Mehboob Ansari Assistant Professor, D.S.T.S. Mandal's College of Pharmacy, Shivdare Campus, Vijapur Road, Solapur, Maharashtra - 413004 3. Mr. Mohit Chadha Assistant Professor, Baba Farid College of Pharmacy, Mullanpur, Ludhiana, Punjab - 142023 4. Dr. Mohammed Altaf Ahmed Principal, Ayesha College of Pharmacy, Hagarga Cross ring Road, Kalaburagi, Karnataka - 585104 , et al.</b>	

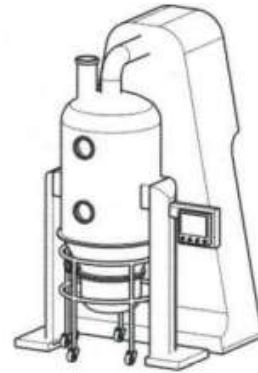



पेटेंट कार्यालय  
शासकीय जर्नल

**OFFICIAL JOURNAL  
OF  
THE PATENT OFFICE**

---

---

निर्गमन सं. 28/2023  
ISSUE NO. 28/2023

शुक्रवार  
**FRIDAY**

दिनांक: 14/07/2023  
DATE: 14/07/2023

---

---

पेटेंट कार्यालय का एक प्रकाशन  
PUBLICATION OF THE PATENT OFFICE

**INTRODUCTION**

In view of the recent amendment made in the Designs (Amendment) Rules, 2008 with effect from 17/06/2008, Publication of the matter relating to Designs is being published in the Official Journal of The Patent Office. This Journal is being published on weekly basis on every Friday covering the various proceedings on Designs as required according to the provisions of under Rule 22, 25, 27 and 39 of the Design (Amendment) Rules, 2008. All the enquiries on this Official Journal and other information as required by the public should be addressed to the Controller General of Patents, Designs & Trade Marks. Suggestions and comments are requested from all quarters so that the content can be enriched.

## Design Application Details

**Application Number:** 383360-001  
**Cbr Number:** 204412  
**Cbr Date:** 08/04/2023 13:54:44  
**Applicant Name:**  
1. Dr. V Lokeswara Babu  
2. Dr. Nihar Ranjan Kar  
3. Professor Shital Vijay Sirsat  
4. Dr. B. Srinivas  
5. Dr. Abhishek Bhattacharjee  
6. Dr. Anoop Kumar N  
7. Aakrshan Kumar  
8. Dr. Sandhya S  
9. P.Prapulla  
10. Mr. Rajat  
11. Satyabrata Jena

## Design Application Status

**Application Status:** Design Accepted and Published, Journal No is 28/2023 and Journal Date is 14/07/2023

[Back](#)

<b>Design Number</b>	<b>383360-001</b>
<b>Class</b>	15-99
<b>Date of Registration</b>	08/04/2023
<b>Title</b>	AUTOMATED TABLET PACKAGING MACHINE
<b>Priority NA</b>	
<b>1. Dr. V Lokeswara Babu HOD &amp; Associate Professor, Department of Pharmaceutics, Bhaskar Pharmacy College, Bhaskar Nagar, Rangareddy District, Hyderabad, Telangana, India -500075. 2. Dr. Nihar Ranjan Kar Assistant Professor, Centurion University of Technology and Management, Gopalpur, Balasore, Odisha, India -756044. 3. Professor Shital Vijay Sirsat Associate Professor, Department of Pharmaceutics, Shri Sant Gajanan Maharaj College of Pharmacy Buldhana, Maharashtra, India, Near Palnagar, Sagwan Road, At post Buldhana, Tal and District -Buldhana, India-443001. 4. Dr. B. Srinivas Assistant Professor, Department of Chemistry, Rajiv Gandhi University of Knowledge Technologies (RGUKT) Basar, Nirmal, Telangana, India - 504107. , et al.</b>	

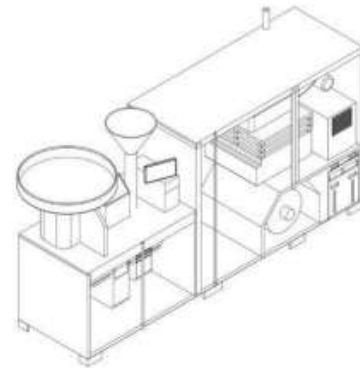



ORIGINAL  
क्रम सं/ Serial No. : 140712



**पेटेंट कार्यालय, भारत सरकार | The Patent Office, Government Of India**

**डिजाइन के पंजीकरण का प्रमाण पत्र | Certificate of Registration of Design**

डिजाइन सं. / Design No. : 383360-001

तारीख / Date : 08/04/2023

पारस्परिकता तारीख / Reciprocity Date\* : -

देश / Country : -

प्रमाणित किया जाता है कि संलग्न प्रति में वर्णित डिजाइन जो **AUTOMATED TABLET PACKAGING MACHINE** से संबंधित है, का पंजीकरण, श्रेणी 15-99 में 1.Dr. V Lokeswara Babu 2. Dr. Nihar Ranjan Kar 3.Professor Shital Vijay Sirsat 4.Dr. B. Srinivas 5.Dr. Abhishek Bhattacharjee 6.Dr. Anoop Kumar N 7.Aakrshan Kumar 8.Dr. Sandhya S 9.P.Prapulla 10.Mr. Rajat 11.Satyabrata Jena के नाम में उपर्युक्त संख्या और तारीख में कर लिया गया है।

Certified that the design of which a copy is annexed hereto has been registered as of the number and date given above in class 15-99 in respect of the application of such design to **AUTOMATED TABLET PACKAGING MACHINE** in the name of 1.Dr. V Lokeswara Babu 2. Dr. Nihar Ranjan Kar 3.Professor Shital Vijay Sirsat 4.Dr. B. Srinivas 5.Dr. Abhishek Bhattacharjee 6.Dr. Anoop Kumar N 7.Aakrshan Kumar 8.Dr. Sandhya S 9.P.Prapulla 10.Mr. Rajat 11.Satyabrata Jena.

डिजाइन अधिनियम, 2000 तथा डिजाइन नियम, 2001 के अधधीन प्रावधानों के अनुसरण में।

In pursuance of and subject to the provisions of the Designs Act, 2000 and the Designs Rules, 2001.

जारी करने की तिथि : 13/07/2023  
Date of Issue



महानियंत्रक पेटेंट, डिजाइन और व्यापार चिह्न  
Controller General of Patents, Designs and Trade Marks

\*पारस्परिकता तारीख (यदि कोई हो) जिसकी अनुमति दी गई है तथा देश का नाम। डिजाइन का स्वत्वाधिकार पंजीकरण की तारीख से दस वर्षों के लिए होगा जिसका विस्तार, अधिनियम एवं नियम के निबंधनों के अधीन, पाँच वर्षों की अतिरिक्त अवधि के लिए किया जा सकेगा। इस प्रमाण पत्र का उपयोग विधिक कार्यवाहियों अथवा विदेश में पंजीकरण प्राप्त करने के लिए नहीं हो सकता है।

The reciprocity date (if any) which has been allowed and the name of the country. Copyright in the design will subsist for ten years from the date of Registration, and may under the terms of the Act and Rules, be extended for a further period of five years. This Certificate is not for use in legal proceedings or for obtaining registration abroad.



Intellectual  
Property  
Office

# Certificate of Registration for a UK Design

Design number: 6288630

Grant date: 17 June 2023

Registration date: 08 June 2023

## This is to certify that,

in pursuance of and subject to the provision of Registered Designs Act 1949, the design of which a representation or specimen is attached, had been registered as of the date of registration shown above in the name of

Dr. Chinmaya Mahapatra, Dr. Subas Chandra Dinda, Dr. Hara Prasad Mishra,

Ms. Smruti Sikta Mishra, Mr. Abhra Das, Dr. Lubhan Singh, Mr.Om Prakash

Panda, Mr.Sanatan Nayak

in respect of the application of such design to:

IOT Device for Breast Cancer Detection

International Design Classification:

Version: 14-2023

Class: 24 MEDICAL AND LABORATORY EQUIPMENT

Subclass: 01 APPARATUS AND EQUIPMENT FOR DOCTORS, HOSPITALS  
AND LABORATORIES

## Adam Williams

Comptroller-General of Patents, Designs and Trade Marks

Intellectual Property Office

The attention of the Proprietor(s) is drawn to the important notes overleaf.





**Representation of Designs**

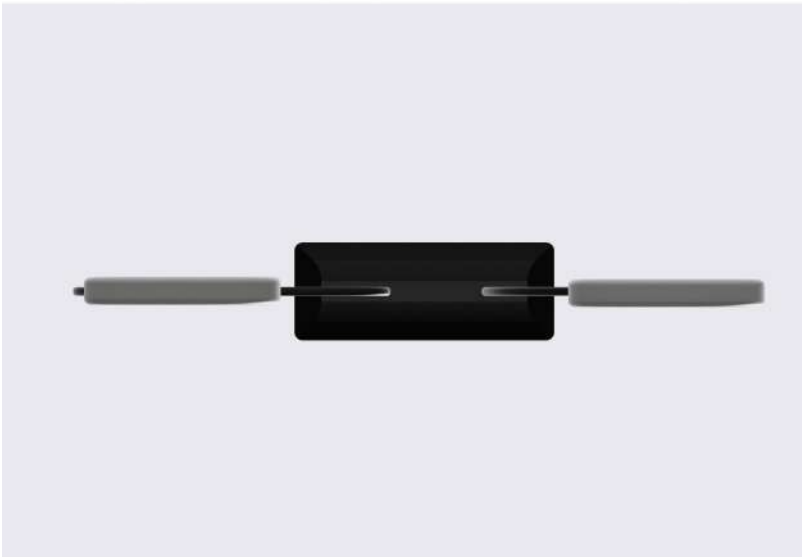

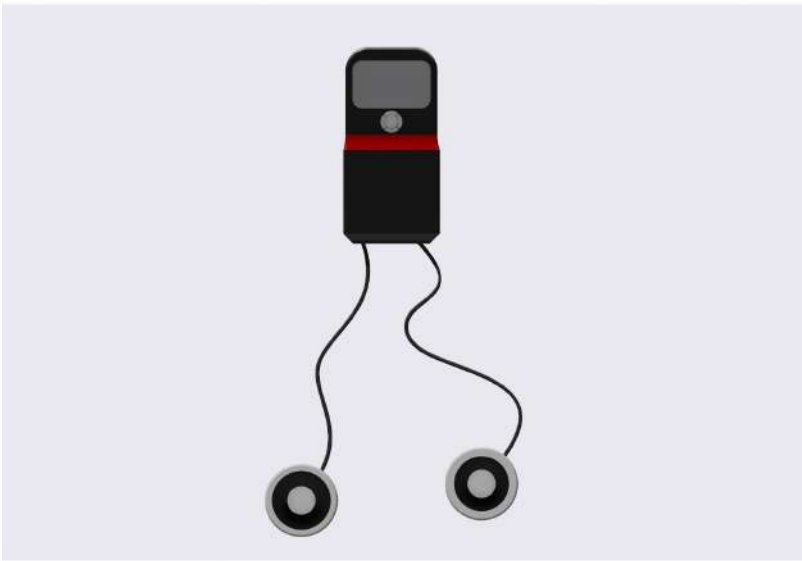

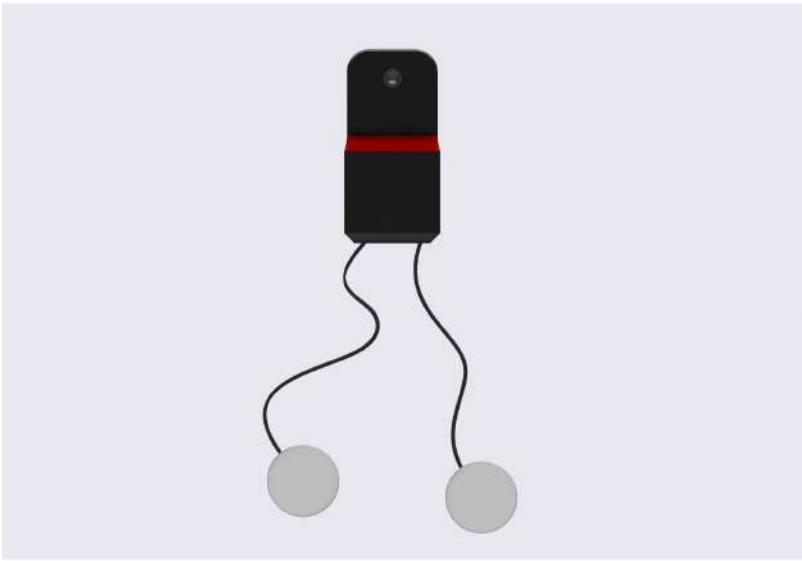
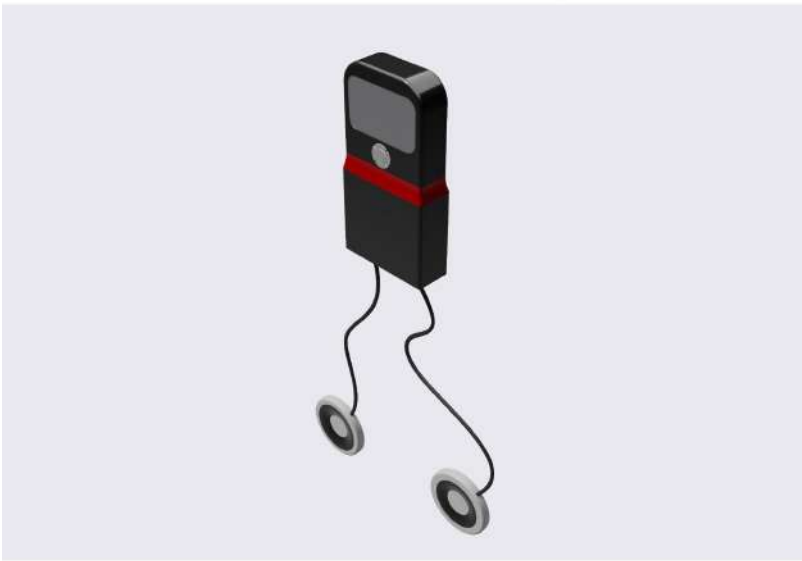



Intellectual Property Office is an operating name of the Patent Office

[www.gov.uk/ipo](http://www.gov.uk/ipo)



Intellectual  
Property  
Office

## Certificate of Registration for a UK Design

Design number: 6303706

Grant date: 24 August 2023

Registration date: 15 August 2023

### This is to certify that,

in pursuance of and subject to the provision of Registered Designs Act 1949, the design of which a representation or specimen is attached, had been registered as of the date of registration shown above in the name of

Dr. Senthil Kumar Jagatheesan, Dr. Hridayanand Singh, Rouful Alam Bhat, Ms.

Rupali Madhukar Barhate, Mr. Jagatjit Das , Ms. Vaishnavi Balu Raskar, Mr.

Swapnil Kailash Gorde, Dr. Sadhana R Shahi, Sonam Bhutia, Dr. Ankit Jain ,

Amar Kumar Maheshbhai Raval

in respect of the application of such design to:

Non-invasive device for glucose monitoring in diabetic patients

International Design Classification:

Version: 14-2023

Class: 24 MEDICAL AND LABORATORY EQUIPMENT

Subclass: 01 APPARATUS AND EQUIPMENT FOR DOCTORS, HOSPITALS  
AND LABORATORIES

### **Adam Williams**

Comptroller-General of Patents, Designs and Trade Marks  
Intellectual Property Office

The attention of the Proprietor(s) is drawn to the important notes overleaf.



**Representation of Designs**



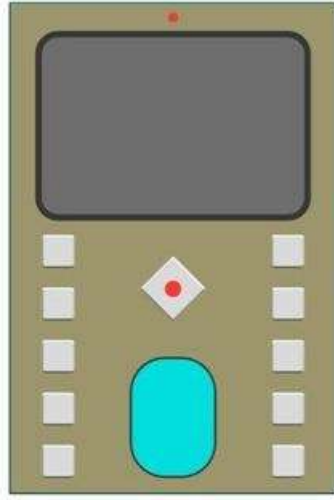







Intellectual Property Office is an operating name of the Patent Office

[www.gov.uk/ipo](http://www.gov.uk/ipo)



Intellectual  
Property  
Office

# Certificate of Registration for a UK Design

Design number: 6307009

Grant date: 09 September 2023

Registration date: 01 September 2023

## This is to certify that,

in pursuance of and subject to the provision of Registered Designs Act 1949, the design of which a representation or specimen is attached, had been registered as of the date of registration shown above in the name of

Dr.Ashish Kumar Sarangi, Dr.Himansu Bhusan Samal, Dr.Fahima Dilnawaz,

Dr.Kalpita Bhatta

in respect of the application of such design to:

Laparoscopic Instruments

International Design Classification:

Version: 14-2023

Class: 24 MEDICAL AND LABORATORY EQUIPMENT

Subclass: 02 MEDICAL INSTRUMENTS, INSTRUMENTS AND TOOLS FOR LABORATORY USE

### **Adam Williams**

Comptroller-General of Patents, Designs and Trade Marks

Intellectual Property Office

The attention of the Proprietor(s) is drawn to the important notes overleaf.



Representation of Designs



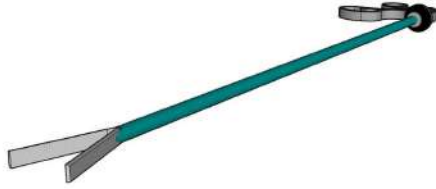

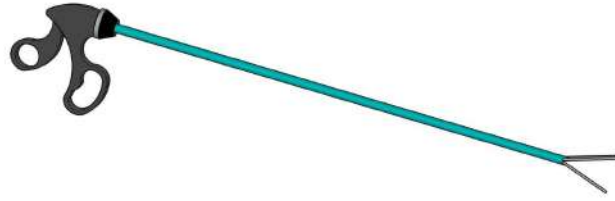

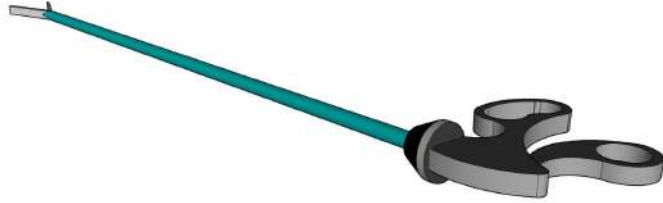

Intellectual Property Office is an operating name of the Patent Office

[www.gov.uk/ipo](http://www.gov.uk/ipo)



Intellectual  
Property  
Office

# Certificate of Registration for a UK Design

Design number: 6300181

Grant date: 08 August 2023

Registration date: 29 July 2023

## This is to certify that,

in pursuance of and subject to the provision of Registered Designs Act 1949, the design of which a representation or specimen is attached, had been registered as of the date of registration shown above in the name of

Prof. (Dr.) Seema Tomar , Dr.Nasyam Mohammed Akram, Dr. Shaveta Ahalwat,

Mr. Sonu Dewaji Gathe, Dr. Thoppalada. Yunus Pasha, Ajay Kumar Verma, Dr.

Swati Gupta, Dr. Gyanranjan Mahalik, Dr. Annu Mudgal, Ms.Praneetha

Visampalli

in respect of the application of such design to:

DOUBLE DISTILLATION APPARATUS FOR SEPARATION OF ORGANIC

COMPOUNDS

International Design Classification:

Version: 14-2023

Class: 24 MEDICAL AND LABORATORY EQUIPMENT

Subclass: 02 MEDICAL INSTRUMENTS, INSTRUMENTS AND TOOLS FOR LABORATORY USE

**Adam Williams**

Comptroller-General of Patents, Designs and Trade Marks

Intellectual Property Office

The attention of the Proprietor(s) is drawn to the important notes overleaf.



Representation of Designs

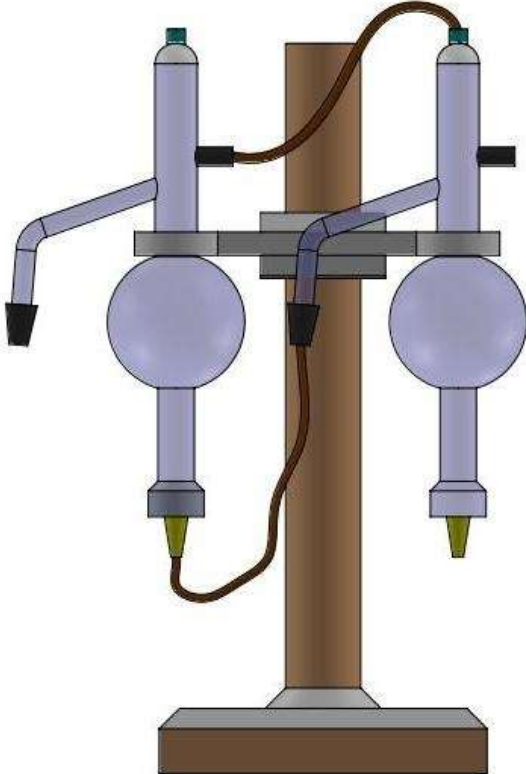
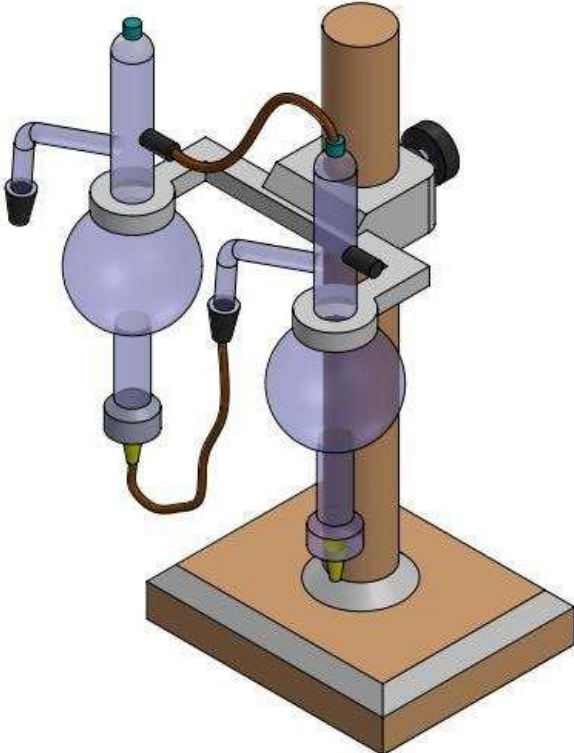



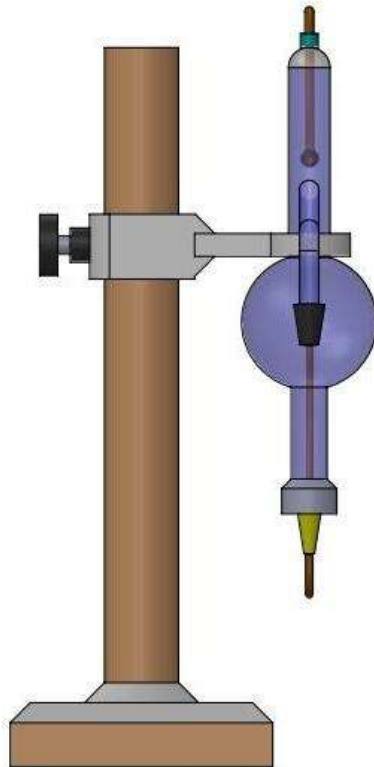
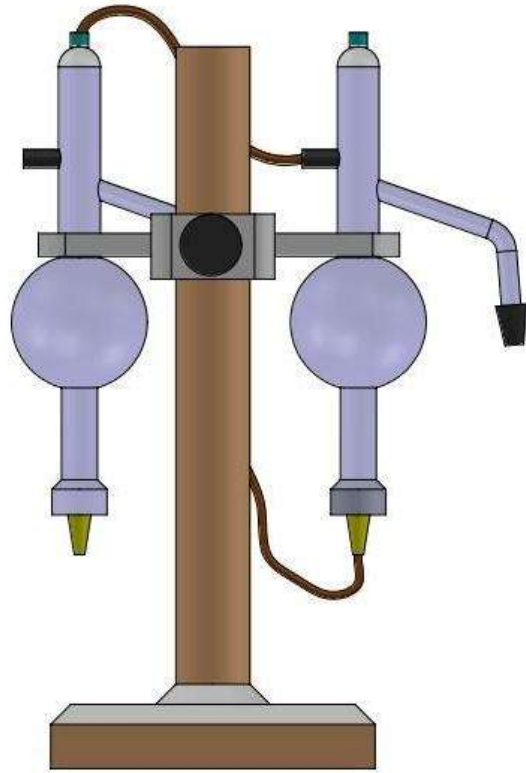

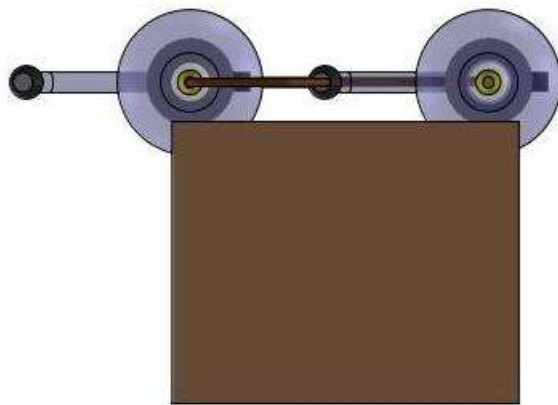
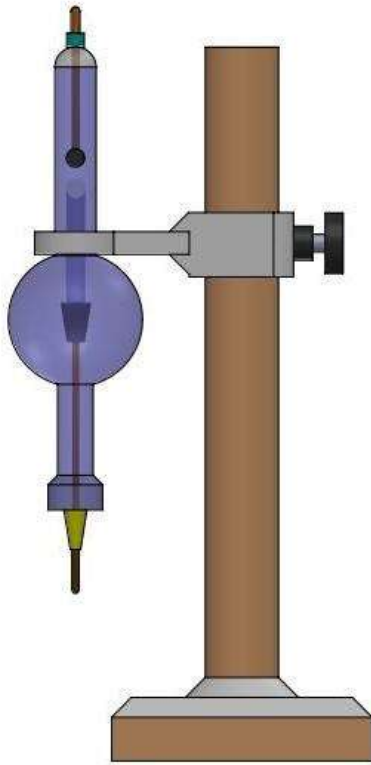

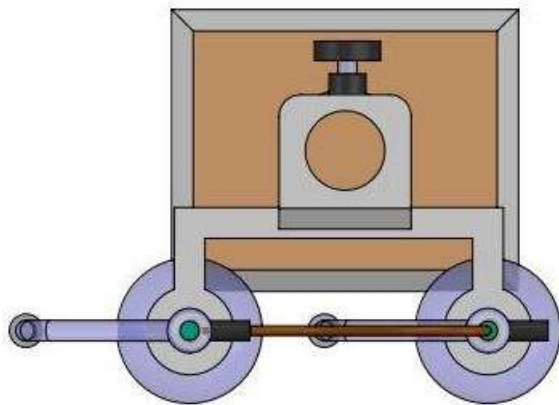

Intellectual Property Office is an operating name of the Patent Office

[www.gov.uk/ipo](http://www.gov.uk/ipo)



Intellectual  
Property  
Office

## Certificate of Registration for a UK Design

Design number: 6308140

Grant date: 13 September 2023

Registration date: 06 September 2023

### This is to certify that,

in pursuance of and subject to the provision of Registered Designs Act 1949, the design of which a representation or specimen is attached, had been registered as of the date of registration shown above in the name of

Mr. Kundavaram Raju, Dr. Vimal Kumar Shanmugavelu, Mr. Bhaskar Jyoti

Pathak, Mrs. Divyanshi Kothari, Dr. Mohammad Wais, Dr. Mohd Mazhar, Mr.

Azad Nabilal Dhage, Mr. Kartikey Pandey, Mr. Rakesh Meher, Mr. Shatrughna

Uttam Nagrik

in respect of the application of such design to:

Portable Device Used for Measuring cystic fibrosis through Saliva

International Design Classification:

Version: 14-2023

Class: 24 MEDICAL AND LABORATORY EQUIPMENT

Subclass: 02 MEDICAL INSTRUMENTS, INSTRUMENTS AND TOOLS FOR LABORATORY USE

### **Adam Williams**

Comptroller-General of Patents, Designs and Trade Marks  
Intellectual Property Office

The attention of the Proprietor(s) is drawn to the important notes overleaf.



Representation of Designs

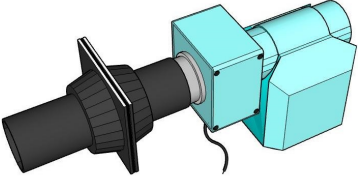
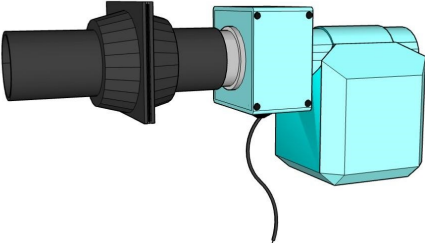

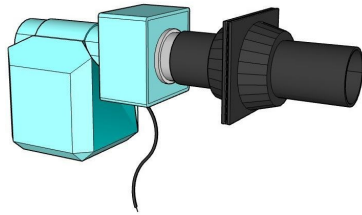
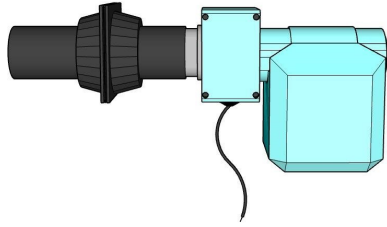

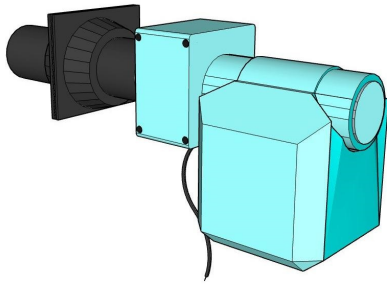
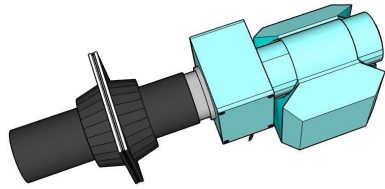

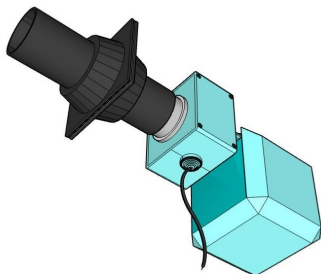

Intellectual Property Office is an operating name of the Patent Office

[www.gov.uk/ipo](http://www.gov.uk/ipo)



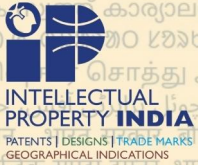

ORIGINAL

क्रम सं/ Serial No. : 143649



**पेटेंट कार्यालय, भारत सरकार | The Patent Office, Government Of India**

**डिजाइन के पंजीकरण का प्रमाण पत्र | Certificate of Registration of Design**

डिजाइन सं. / Design No. : 388845-001

तारीख / Date : 22/06/2023

पारस्परिकता तारीख / Reciprocity Date\* :

देश / Country :

प्रमाणित किया जाता है कि संलग्न प्रति में वर्णित डिजाइन जो **SOLAR POWERED DEVICE TO TRACK NUTRIENTS IN AGRI**

**WATER** से संबंधित है, का पंजीकरण, श्रेणी 10-05 में 1.Dr.Bijaya Bijeta Nayak 2. Dr. Shiv Sankar Das 3.Ms. Debashree Debadatta Behera 4.Dr.Akankshya Patnaik 5.Dr.Kshitish Kumar Khuntia 6.Mr. Satya Prakash Lenka के नाम में उपर्युक्त संख्या और तारीख में कर लिया गया है।

Certified that the design of which a copy is annexed hereto has been registered as of the number and date given above in class 10-05 in respect of the application of such design to **SOLAR POWERED DEVICE TO TRACK NUTRIENTS IN AGRI**

**WATER** in the name of 1.Dr.Bijaya Bijeta Nayak 2. Dr. Shiv Sankar Das 3.Ms. Debashree Debadatta Behera 4.Dr.Akankshya Patnaik 5.Dr.Kshitish Kumar Khuntia 6.Mr. Satya Prakash Lenka.

डिजाइन अधिनियम, 2000 तथा डिजाइन नियम, 2001 के अधधीन प्रावधानों के अनुसरण में।

In pursuance of and subject to the provisions of the Designs Act, 2000 and the Designs Rules, 2001.



*[Signature]*

महानियंत्रक पेटेंट, डिजाइन और व्यापार चिह्न  
Controller General of Patents, Designs and Trade Marks

जारी करने की तिथि : 12/09/2023  
Date of Issue

\*पारस्परिकता तारीख (यदि कोई हो) जिसकी अनुमति दी गई है तथा देश का नाम। डिजाइन का स्वत्वाधिकार पंजीकरण की तारीख से दस वर्षों के लिए होगा जिसका विस्तार, अधिनियम एवं नियम के निबंधनों के अधीन, पाँच वर्षों की अतिरिक्त अवधि के लिए किया जा सकेगा। इस प्रमाण पत्र का उपयोग विधिक कार्यवाहियों अथवा विदेश में पंजीकरण प्राप्त करने के लिए नहीं हो सकता है।  
The reciprocity date (if any) which has been allowed and the name of the country. Copyright in the design will subsist for ten years from the date of Registration, and may under the terms of the Act and Rules, be extended for a further period of five years. This Certificate is not for use in legal proceedings or for obtaining registration abroad.





Intellectual  
Property  
Office

# Certificate of Registration for a UK Design

Design number: 6310504

Grant date: 23 September 2023

Registration date: 14 September 2023

## This is to certify that,

in pursuance of and subject to the provision of Registered Designs Act 1949, the design of which a representation or specimen is attached, had been registered as of the date of registration shown above in the name of

Prof. (Dr.) Varsha Deva, Razique Anwer, Shoeb Mustafa, Saif Ahmed, Seema

Paragannavar, Dr Chakrapani Ramesh, Dr. Soumya Jal, Binapani Barik, Dr.

Harshal Ashok Pawar, Dr Vashisth Pankajkumar Bhavsar

in respect of the application of such design to:

Device to detect anticancer activity of coumarin derivatives

International Design Classification:

Version: 14-2023

Class: 24 MEDICAL AND LABORATORY EQUIPMENT

Subclass: 01 APPARATUS AND EQUIPMENT FOR DOCTORS, HOSPITALS  
AND LABORATORIES

## Adam Williams

Comptroller-General of Patents, Designs and Trade Marks

Intellectual Property Office

The attention of the Proprietor(s) is drawn to the important notes overleaf.



Representation of Designs

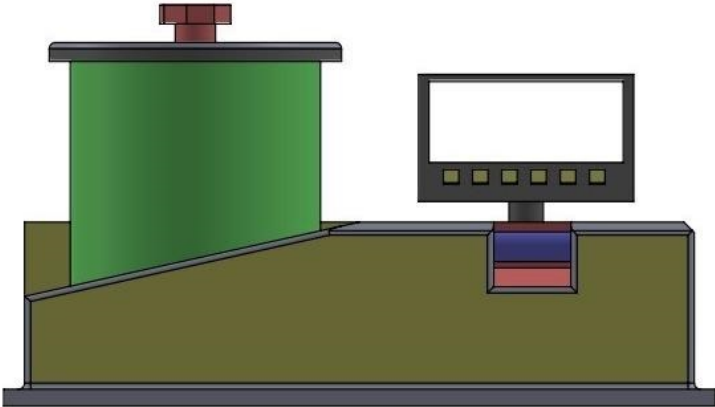
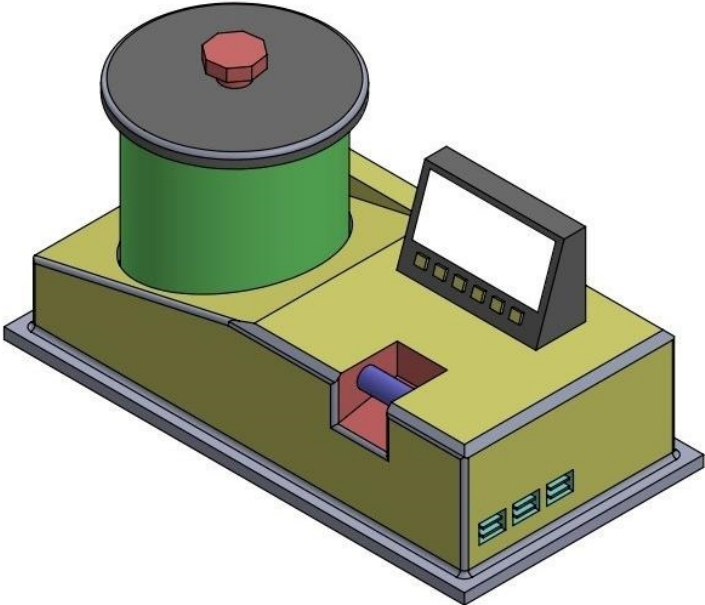

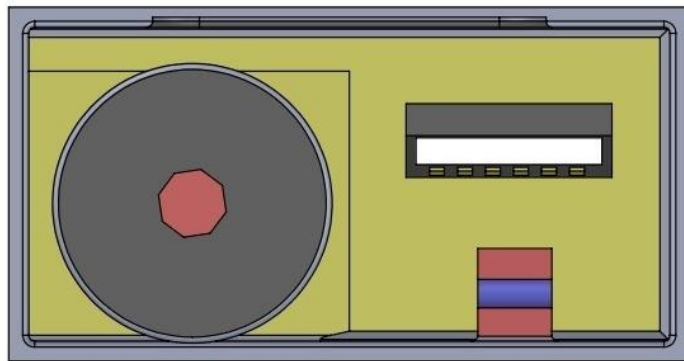
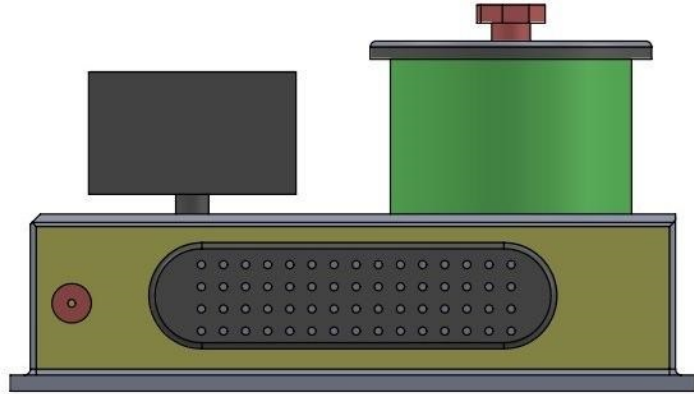

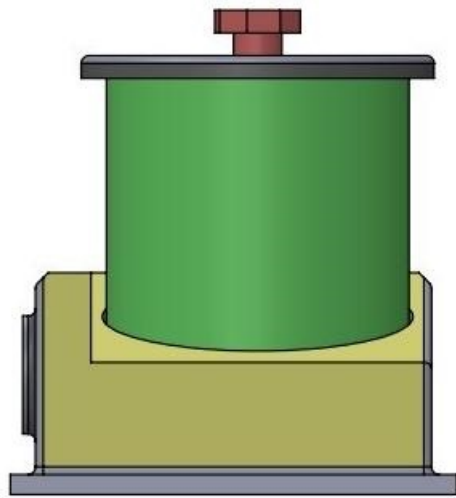

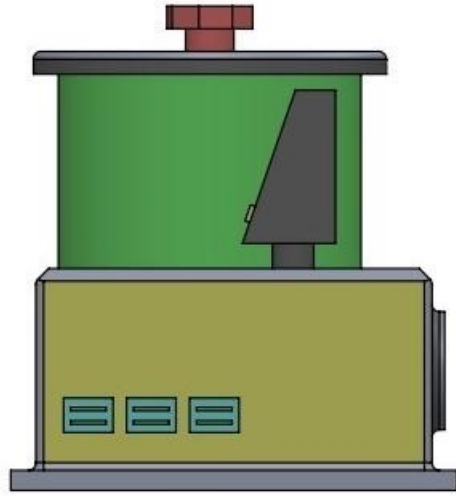

Intellectual Property Office is an operating name of the Patent Office

[www.gov.uk/ipo](http://www.gov.uk/ipo)



Intellectual  
Property  
Office

# Certificate of Registration for a UK Design

Design number: 6316607

Grant date: 10 October 2023

Registration date: 03 October 2023

## This is to certify that,

in pursuance of and subject to the provision of Registered Designs Act 1949, the design of which a representation or specimen is attached, had been registered as of the date of registration shown above in the name of

Mr. Abhinav Anand, Mr. Suman Kumar Mekap, Dr. Sandhya Subhadra,

Kuchibhotla Phani Sarada Praneetha , Sabita Sahoo, Satyabrata Jena, Ms.

Neelam Kumari , Dr. Daisy Sharma

in respect of the application of such design to:

**ELECTROCONVULSIOMETER APPARATUS**

International Design Classification:

Version: 14-2023

Class: 24 MEDICAL AND LABORATORY EQUIPMENT

Subclass: 01 APPARATUS AND EQUIPMENT FOR DOCTORS, HOSPITALS  
AND LABORATORIES

**Adam Williams**

Comptroller-General of Patents, Designs and Trade Marks

Intellectual Property Office

The attention of the Proprietor(s) is drawn to the important notes overleaf.



Intellectual Property Office is an operating name of the Patent Office

[www.gov.uk/ipo](http://www.gov.uk/ipo)



Representation of Designs

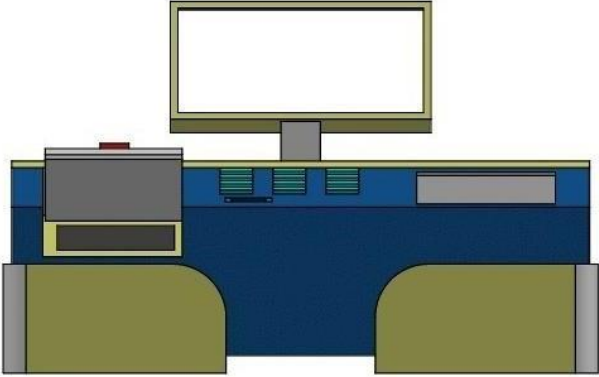
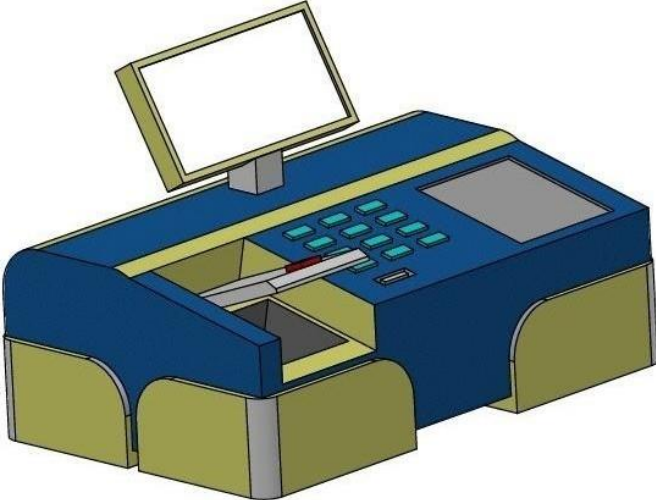

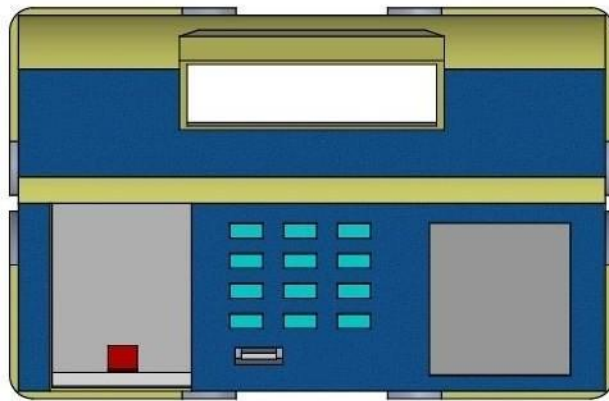
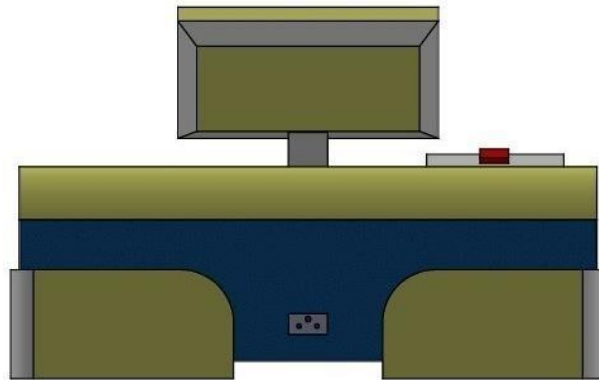

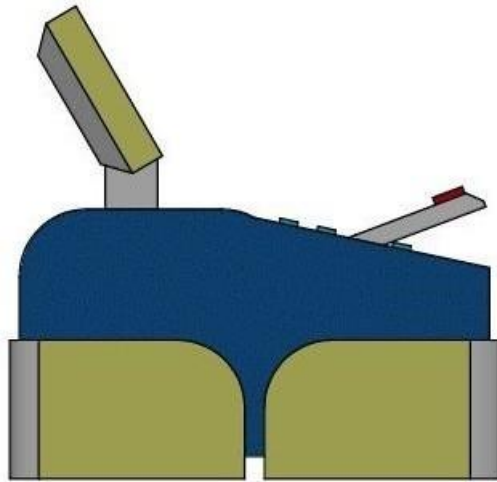
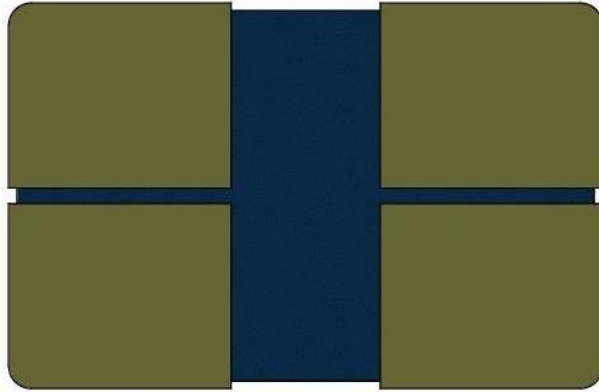

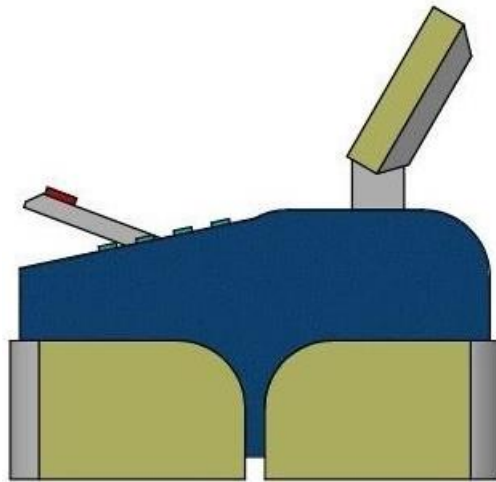

Intellectual Property Office is an operating name of the Patent Office

[www.gov.uk/ipo](http://www.gov.uk/ipo)

