



ORIGINAL

No. 96351

भारत सरकार
GOVERNMENT OF INDIA
पेटेंट कार्यालय
THE PATENT OFFICE

CERTIFICATE OF REGISTRATION OF DESIGN

Design No. 330537-001
Date 29/06/2020 23:11:27
Reciprocity Date*
Country

Certified that the design of which a copy is annexed hereto has been registered as of the number and date given above in class 12-08 in respect of the application of such design to COMPACT COMMERCIAL ELECTRIC VEHICLE in the name of CENTURION UNIVERSITY OF TECHNOLOGY & MANAGEMENT (CUTM), AT-ALLURI NAGAR, PO-R.SITAPUR, VIA-UPPALADA, PARLAKHEMUNDI-761211, GAJAPATI DIST, ODISHA, INDIA

in pursuance of and subject to the provisions of the Designs Act, 2000 and the Designs Rules, 2001.

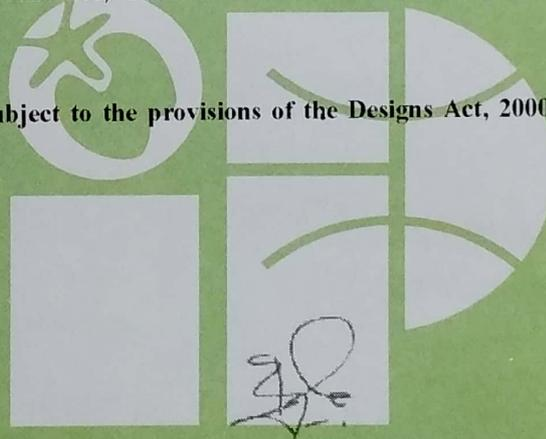

Controller General of Patents, Designs and Trade Marks

*The reciprocity date (if any) which has been allowed and the name of the country.

Copyright in the design will subsist for ten years from the date of Registration, and may under the terms of the Act and Rules, be extended for a further period of five years.

This Certificate is not for use in legal proceedings or for obtaining registration abroad

HIMA BINDU ATTI,
NOVEL PATENT SERVICES PVT LTD HIG-421,
MANSITA, ABOVE PUNJAB NATIONAL BANK,
MIDHILAPURI VUDA COLONY, P.M.PALEM,
VISA KHAPATNAM-530041, ANDHRA PRADESH,
INDIA

Date of Issue 08/03/2021 13:03:35

INTELLECTUAL
PROPERTY INDIA
PATENTS | DESIGNS | TRADE MARKS
GEOGRAPHICAL INDICATIONS

(SPECIMEN OF REPRESENTATION SHEETS)

Name of the Applicant:

No. of sheets: 6

Centurion University of Technology & Management (CUTM) Sheet No: 1



Perspective view



The Novelty resides in the shape and configuration of an "Electric vehicle" as illustrated.

No claim is made by virtue of this registration in respect of any mechanical or other action of the mechanism whatever or in respect of any mode or principle of construction of the article.

No claim is made by virtue of the registration to any right to the exclusive use of the words, letters, numbers, colour, combination or *Reflection* Trade Marks as appearing in the representation.

Date: 12/12/2020

Hima Bindu Atti
Hima Bindu Atti
Patent Agent

330537-01

29 JUN 2020

(SPECIMEN OF REPRESENTATION SHEETS)

Name of the Applicant:

No. of sheets: 6

Centurion University of Technology & Management (CUTM) Sheet No: 2

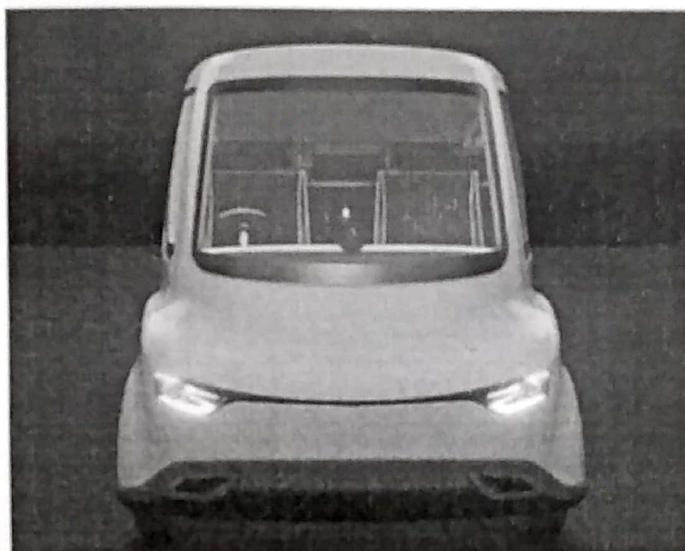

Front view

The Novelty resides in the shape and configuration of an "Electric vehicle" as illustrated.

No claim is made by virtue of this registration in respect of any mechanical or other action of the mechanism whatever or in respect of any mode or principle of construction of the article.

No claim is made by virtue of the registration to any right to the exclusive use of the words, letters, numbers, colour, combination or *Reflection* Trade Marks as appearing in the representation.

Date: 12/12/2020

Hima Bindu

Hima Bindu Atti

Patent Agent

330537 - 001

29 JUN 2020

(SPECIMEN OF REPRESENTATION SHEETS)

Name of the Applicant:

No. of sheets: 6

Centurion University of Technology & Management (CUTM) Sheet No: 3

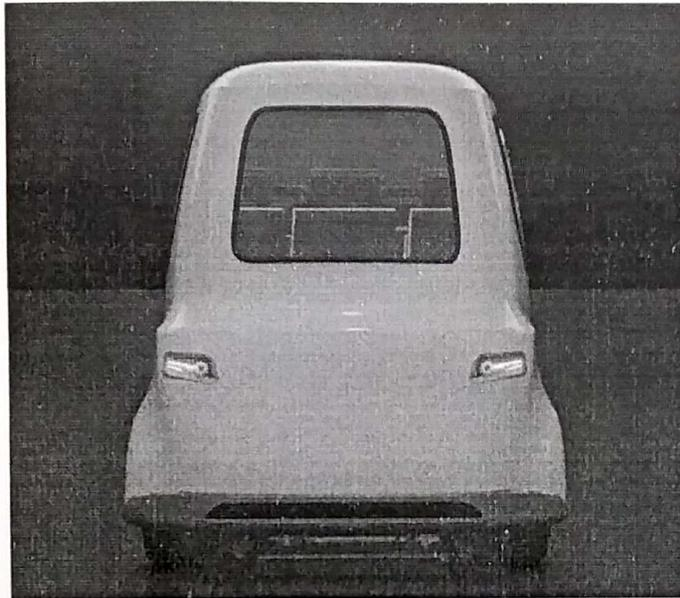

Back view

The Novelty resides in the shape and configuration of an "Electric vehicle" as illustrated.

No claim is made by virtue of this registration in respect of any mechanical or other action of the mechanism whatever or in respect of any mode or principle of construction of the article.

No claim is made by virtue of the registration to any right to the exclusive use of the words, letters, numbers, colour, combination or *Reflection* Trade Marks as appearing in the representation.

Date: 12/12/2020

Hima Bindu
Hima Bindu Atti
Patent Agent

330537-001

29 JUN 2020

(SPECIMEN OF REPRESENTATION SHEETS)

Name of the Applicant: Centurion University of Technology & Management (CUTM) Sheet No: 4
No. of sheets: 6

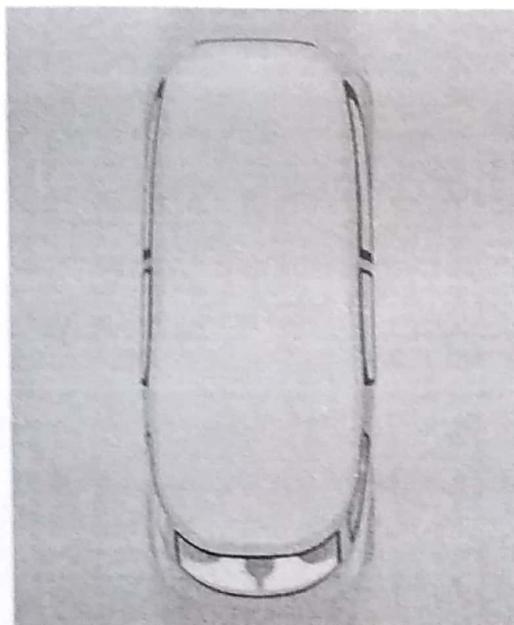

Top view

The Novelty resides in the shape and configuration of an "Electric vehicle" as illustrated.

No claim is made by virtue of this registration in respect of any mechanical or other action of the mechanism whatever or in respect of any mode or principle of construction of the article.

No claim is made by virtue of the registration to any right to the exclusive use of the words, letters, numbers, colour, combination or *Reflection* Trade Marks as appearing in the representation.

Date: 12/12/2020

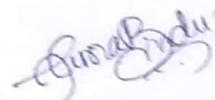

Hima Bindu Atti
Patent Agent

330537-001

29 JUN 2020

(SPECIMEN OF REPRESENTATION SHEETS)

Name of the Applicant:

No. of sheets: 6

Centurion University of Technology & Management (CUTM) Sheet No: 5

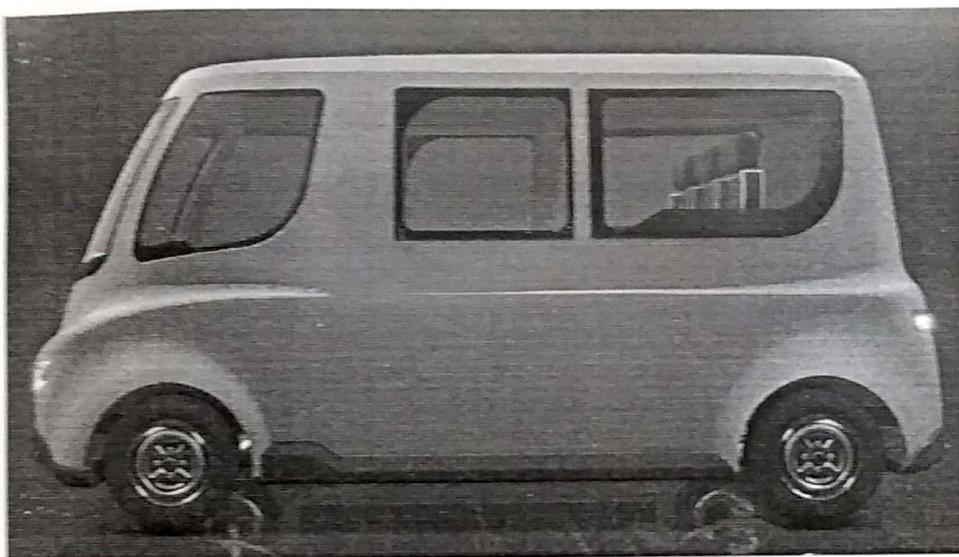

Side View - 1

The Novelty resides in the shape and configuration of an "Electric vehicle" as illustrated.

No claim is made by virtue of this registration in respect of any mechanical or other action of the mechanism whatever or in respect of any mode or principle of construction of the article.

No claim is made by virtue of the registration to any right to the exclusive use of the words, letters, numbers, colour, combination or *Reflection* Trade Marks as appearing in the representation.

Date: 12/12/2020

Hima Bindu Atti

Patent Agent

330537 - 001

29 JUN 2020

(SPECIMEN OF REPRESENTATION SHEETS)

Name of the Applicant:

No. of sheets: 6

Centurion University of Technology & Management (CUTM) Sheet No: 6

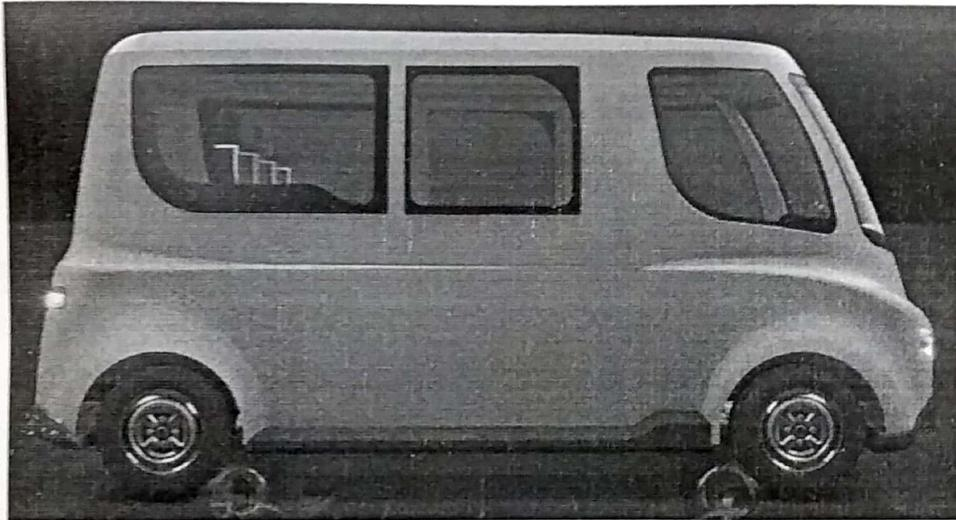

Side View – 2

The Novelty resides in the shape and configuration of an "Electric vehicle" as illustrated.

No claim is made by virtue of this registration in respect of any mechanical or other action of the mechanism whatever or in respect of any mode or principle of construction of the article.

No claim is made by virtue of the registration to any right to the exclusive use of the words, letters, numbers, colour, combination or *Reflection* Trade Marks as appearing in the representation.

Date: 12/12/2020

Hima Bindu Atti

Hima Bindu Atti

Patent Agent

330537 - 001

29 JUN 2020



ORIGINAL

मूल/No : 131007



भारत सरकार
GOVERNMENT OF INDIA
पेटेंट कार्यालय
THE PATENT OFFICE

डिजाइन के पंजीकरण का प्रमाणपत्र
CERTIFICATE OF REGISTRATION OF DESIGN

डिजाइन सं. / Design No. : 376914-001
तारीख / Date : 07/01/2023
पारस्परिकता तारीख / Reciprocity Date* :
देश / Country :

प्रमाणित किया जाता है कि संलग्न प्रति में वर्णित डिजाइन जो **PORTABLE SOLAR VEGETABLES DRYER** से संबंधित है, का पंजीकरण, श्रेणी **07-05** में 1.Dr. Dehani Prasad Mishra 2. Dr.Arun Kumar Sahoo 3.Dr. Ramesh Chandra Mohanty 4.Prof. Nimay Chandra Giri के नाम में उपर्युक्त संख्या और तारीख में कर लिया गया है।

Certified that the design of which a copy is annexed hereto has been registered as of the number and date given above in class **07-05** in respect of the application of such design to **PORTABLE SOLAR VEGETABLES DRYER** in the name of 1.Dr. Dehani Prasad Mishra 2. Dr.Arun Kumar Sahoo 3.Dr. Ramesh Chandra Mohanty 4.Prof. Nimay Chandra Giri.

डिजाइन अधिनियम, 2000 तथा डिजाइन नियम, 2001 के अध्याधीन प्रावधानों के अनुसरण में।

In pursuance of and subject to the provisions of the Designs Act, 2000 and the Designs Rules, 2001.

INTELLECTUAL
PROPERTY INDIA
PATENTS | DESIGNS | TRADE MARKS
GEOGRAPHICAL INDICATIONS

निर्गमन की तारीख/Date of Issue : 15/03/2023

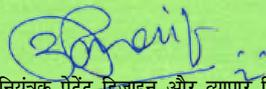
महानियंत्रक पेटेंट डिजाइन और व्यापार चिह्न
Controller General of Patents, Designs and Trade Marks

पारस्परिकता तारीख (यदि कोई हो) जिसकी अनुमति देश के नाम पर की गई है। डिजाइन का सत्त्वाधिकार पंजीकरण की तारीख से दस वर्षों के लिए होगा जिसका विस्तार, अधिनियम एवं नियम के निबंधनों के अधीन, पाँच वर्षों की अतिरिक्त अवधि के लिए किया जा सकेगा। इस प्रमाण पत्र का उपयोग विधिक कार्यवाहियों अथवा विदेश में पंजीकरण प्राप्त करने के लिए नहीं हो सकता है।

*The reciprocity date (if any) which has been allowed and the name of the country. Copyright in the design will subsist for ten years from the date of Registration, and may under the terms of the Act and Rules, be extended for a further period of five years. This Certificate is not for use in legal proceedings or for obtaining registration abroad.



ORIGINAL

मूल/No : 131159



भारत सरकार
GOVERNMENT OF INDIA
पेटेंट कार्यालय
THE PATENT OFFICE

डिजाइन के पंजीकरण का प्रमाणपत्र
CERTIFICATE OF REGISTRATION OF DESIGN

डिजाइन सं. / Design No. : 377791-001
तारीख / Date : 21/01/2023
पारस्परिकता तारीख / Reciprocity Date* :
देश / Country :

प्रमाणित किया जाता है कि संलग्न प्रति में वर्णित डिजाइन जो **POWDER MANUFACTURING UNIT** से संबंधित है, का पंजीकरण, श्रेणी **15-09** में 1.Dr.Bijaya Bijeta Nayak 2. Dr.Sasmita Sahu 3.Dr. Santosh Kumar Nayak 4.Ms. Debashree Debadatta Behera 5.Dr.Shiv Sankar Das 6.Dr.Rita Kumari Sahu के नाम में उपर्युक्त संख्या और तारीख में कर लिया गया है।

Certified that the design of which a copy is annexed hereto has been registered as of the number and date given above in class **15-09** in respect of the application of such design to **POWDER MANUFACTURING UNIT** in the name of 1.Dr.Bijaya Bijeta Nayak 2. Dr.Sasmita Sahu 3.Dr. Santosh Kumar Nayak 4.Ms. Debashree Debadatta Behera 5.Dr.Shiv Sankar Das 6.Dr.Rita Kumari Sahu.

डिजाइन अधिनियम, 2000 तथा डिजाइन नियम, 2001 के अध्याधीन प्रावधानों के अनुसरण में।

In pursuance of and subject to the provisions of the Designs Act, 2000 and the Designs Rules, 2001.

INTELLECTUAL
PROPERTY INDIA
PATENTS | DESIGNS | TRADE MARKS
GEOGRAPHICAL INDICATIONS

निर्गमन की तारीख/Date of Issue : 16/03/2023

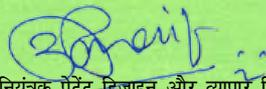
महानियंत्रक पेटेंट डिजाइन और व्यापार चिह्न
Controller General of Patents, Designs and Trade Marks

पारस्परिकता तारीख (यदि कोई हो) जिसकी अनुमति देश के नाम पर की गई है। डिजाइन का सत्त्वाधिकार पंजीकरण की तारीख से दस वर्षों के लिए होगा जिसका विस्तार, अधिनियम एवं नियम के निबंधनों के अधीन, पाँच वर्षों की अतिरिक्त अवधि के लिए किया जा सकेगा। इस प्रमाण पत्र का उपयोग विधिक कार्यवाहियों अथवा विदेश में पंजीकरण प्राप्त करने के लिए नहीं हो सकता है।

*The reciprocity date (if any) which has been allowed and the name of the country. Copyright in the design will subsist for ten years from the date of Registration, and may under the terms of the Act and Rules, be extended for a further period of five years. This Certificate is not for use in legal proceedings or for obtaining registration abroad.



ORIGINAL

मूल/No : 131380



भारत सरकार
GOVERNMENT OF INDIA
पेटेंट कार्यालय
THE PATENT OFFICE

डिजाइन के पंजीकरण का प्रमाणपत्र
CERTIFICATE OF REGISTRATION OF DESIGN

डिजाइन सं. / Design No. : 376903-001
तारीख / Date : 07/01/2023
पारस्परिकता तारीख / Reciprocity Date* :
देश / Country :

प्रमाणित किया जाता है कि संलग्न प्रति में वर्णित डिजाइन जो **IOT BASED AGRICULTURE ROBOT FOR PESTICIDES SPRAYING** से संबंधित है, का पंजीकरण, श्रेणी 15-03 में 1.Prof. Prasheet Mishra 2. Dr.Taraprasad Mohapatra 3.Prof.Sudhansu Sekhar Mishra 4.Prof. Nimay Chandra Giri के नाम में उपर्युक्त संख्या और तारीख में कर लिया गया है।

Certified that the design of which a copy is annexed hereto has been registered as of the number and date given above in class 15-03 in respect of the application of such design to **IOT BASED AGRICULTURE ROBOT FOR PESTICIDES SPRAYING** in the name of 1.Prof. Prasheet Mishra 2. Dr.Taraprasad Mohapatra 3.Prof.Sudhansu Sekhar Mishra 4.Prof. Nimay Chandra Giri.

डिजाइन अधिनियम, 2000 तथा डिजाइन नियम, 2001 के अध्याधीन प्रावधानों के अनुसरण में।

In pursuance of and subject to the provisions of the Designs Act, 2000 and the Designs Rules, 2001.

INTELLECTUAL
PROPERTY INDIA
PATENTS | DESIGNS | TRADE MARKS
GEOGRAPHICAL INDICATIONS

निर्गमन की तारीख/Date of Issue : 20/03/2023

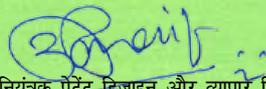
महानियंत्रक पेटेंट डिजाइन और व्यापार चिह्न
Controller General of Patents, Designs and Trade Marks

पारस्परिकता तारीख (यदि कोई हो) जिसकी अनुमति देश के नाम पर की गई है। डिजाइन का सत्त्वाधिकार पंजीकरण की तारीख से दस वर्षों के लिए होगा जिसका विस्तार, अधिनियम एवं नियम के निबंधनों के अधीन, पाँच वर्षों की अतिरिक्त अवधि के लिए किया जा सकेगा। इस प्रमाण पत्र का उपयोग विधिक कार्यवाहियों अथवा विदेश में पंजीकरण प्राप्त करने के लिए नहीं हो सकता है।

*The reciprocity date (if any) which has been allowed and the name of the country. Copyright in the design will subsist for ten years from the date of Registration, and may under the terms of the Act and Rules, be extended for a further period of five years. This Certificate is not for use in legal proceedings or for obtaining registration abroad.



ORIGINAL

मूल/No : 131381



भारत सरकार
GOVERNMENT OF INDIA
पेटेंट कार्यालय
THE PATENT OFFICE

डिजाइन के पंजीकरण का प्रमाणपत्र
CERTIFICATE OF REGISTRATION OF DESIGN

डिजाइन सं. / Design No. : 376944-001
तारीख / Date : 07/01/2023
पारस्परिकता तारीख / Reciprocity Date* :
देश / Country :

प्रमाणित किया जाता है कि संलग्न प्रति में वर्णित डिजाइन जो **IOT BASED CAMERA FOR HEALTHCARE MANAGEMENT** से संबंधित है, का पंजीकरण, श्रेणी **16-01** में 1.Prof. Sima Das 2. Prof. Susmita Chakrabarty 3.Ms. Solanki Mitra 4.Prof. Nimay Chandra Giri के नाम में उपर्युक्त संख्या और तारीख में कर लिया गया है।

Certified that the design of which a copy is annexed hereto has been registered as of the number and date given above in class **16-01** in respect of the application of such design to **IOT BASED CAMERA FOR HEALTHCARE MANAGEMENT** in the name of 1.Prof. Sima Das 2. Prof. Susmita Chakrabarty 3.Ms. Solanki Mitra 4.Prof. Nimay Chandra Giri.

डिजाइन अधिनियम, 2000 तथा डिजाइन नियम, 2001 के अध्याधीन प्रावधानों के अनुसरण में।

In pursuance of and subject to the provisions of the Designs Act, 2000 and the Designs Rules, 2001.

INTELLECTUAL
PROPERTY INDIA
PATENTS | DESIGNS | TRADE MARKS
GEOGRAPHICAL INDICATIONS

निर्गमन की तारीख/Date of Issue : 20/03/2023

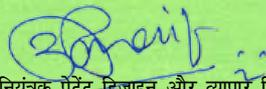
महानियंत्रक पेटेंट डिजाइन और व्यापार चिह्न
Controller General of Patents, Designs and Trade Marks

पारस्परिकता तारीख (यदि कोई हो) जिसकी अनुमति देश के नाम पर की गई है। डिजाइन का सत्त्वाधिकार पंजीकरण की तारीख से दस वर्षों के लिए होगा जिसका विस्तार, अधिनियम एवं नियम के निबंधनों के अधीन, पाँच वर्षों की अतिरिक्त अवधि के लिए किया जा सकेगा। इस प्रमाण पत्र का उपयोग विधिक कार्यवाहियों अथवा विदेश में पंजीकरण प्राप्त करने के लिए नहीं हो सकता है।

*The reciprocity date (if any) which has been allowed and the name of the country. Copyright in the design will subsist for ten years from the date of Registration, and may under the terms of the Act and Rules, be extended for a further period of five years. This Certificate is not for use in legal proceedings or for obtaining registration abroad.



ORIGINAL

मूल/No : 132036



भारत सरकार
GOVERNMENT OF INDIA
पेटेंट कार्यालय
THE PATENT OFFICE

डिजाइन के पंजीकरण का प्रमाणपत्र
CERTIFICATE OF REGISTRATION OF DESIGN

डिजाइन सं. / Design No. : 357339-001
तारीख / Date : 26/01/2022
पारस्परिकता तारीख / Reciprocity Date* :
देश / Country :

प्रमाणित किया जाता है कि संलग्न प्रति में वर्णित डिजाइन जो **E-RICKSHAW** से संबंधित है, का पंजीकरण, श्रेणी **12-11** में 1.Centurion University Of Technology & Management (Cutm) 2. N.Laxmidhar Reddy 3.Sipalin Nayak के नाम में उपर्युक्त संख्या और तारीख में कर लिया गया है।

Certified that the design of which a copy is annexed hereto has been registered as of the number and date given above in class **12-11** in respect of the application of such design to **E-RICKSHAW** in the name of 1.Centurion University Of Technology & Management (Cutm) 2. N.Laxmidhar Reddy 3.Sipalin Nayak.

डिजाइन अधिनियम, 2000 तथा डिजाइन नियम, 2001 के अध्याधीन प्रावधानों के अनुसरण में।

In pursuance of and subject to the provisions of the Designs Act, 2000 and the Designs Rules, 2001.

INTELLECTUAL
PROPERTY INDIA
PATENTS | DESIGNS | TRADE MARKS
GEOGRAPHICAL INDICATIONS

निर्गमन की तारीख/Date of Issue : 28/03/2023

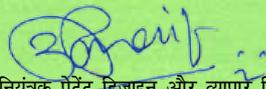
महानियंत्रक पेटेंट डिजाइन और व्यापार चिह्न
Controller General of Patents, Designs and Trade Marks

पारस्परिकता तारीख (यदि कोई हो) जिसकी अनुमति देश के नाम पर की गई है। डिजाइन का सत्त्वाधिकार पंजीकरण की तारीख से दस वर्षों के लिए होगा जिसका विस्तार, अधिनियम एवं नियम के निबंधनों के अधीन, पाँच वर्षों की अतिरिक्त अवधि के लिए किया जा सकेगा। इस प्रमाण पत्र का उपयोग विधिक कार्यवाहियों अथवा विदेश में पंजीकरण प्राप्त करने के लिए नहीं हो सकता है।

*The reciprocity date (if any) which has been allowed and the name of the country. Copyright in the design will subsist for ten years from the date of Registration, and may under the terms of the Act and Rules, be extended for a further period of five years. This Certificate is not for use in legal proceedings or for obtaining registration abroad.



ORIGINAL

मूल/No : 133388



भारत सरकार
GOVERNMENT OF INDIA
पेटेंट कार्यालय
THE PATENT OFFICE

डिजाइन के पंजीकरण का प्रमाणपत्र
CERTIFICATE OF REGISTRATION OF DESIGN

डिजाइन सं. / Design No. : 368071-001
तारीख / Date : 20/07/2022
पारस्परिकता तारीख / Reciprocity Date* :
देश / Country :

प्रमाणित किया जाता है कि संलग्न प्रति में वर्णित डिजाइन जो **SOLAR OPTICAL DESALINATION UNIT** से संबंधित है, का पंजीकरण, श्रेणी **23-03** में 1.Dr. Bijaya Bijeta Nayak 2. Dr. Shiv Sankar Das 3.Ms. Debashree Debadatta Behera 4.Mr. Soumya Ranjan Giri के नाम में उपर्युक्त संख्या और तारीख में कर लिया गया है।

Certified that the design of which a copy is annexed hereto has been registered as of the number and date given above in class **23-03** in respect of the application of such design to **SOLAR OPTICAL DESALINATION UNIT** in the name of 1.Dr. Bijaya Bijeta Nayak 2. Dr. Shiv Sankar Das 3.Ms. Debashree Debadatta Behera 4.Mr. Soumya Ranjan Giri.

डिजाइन अधिनियम, 2000 तथा डिजाइन नियम, 2001 के अध्याधीन प्रावधानों के अनुसरण में।

In pursuance of and subject to the provisions of the Designs Act, 2000 and the Designs Rules, 2001.

INTELLECTUAL
PROPERTY INDIA
PATENTS | DESIGNS | TRADE MARKS
GEOGRAPHICAL INDICATIONS

निर्गमन की तारीख/Date of Issue : 19/04/2023

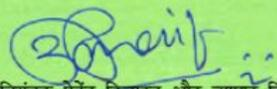
महानियंत्रक पेटेंट-डिजाइन और व्यापार चिह्न
Controller General of Patents, Designs and Trade Marks

पारस्परिकता तारीख (यदि कोई हो) जिसकी अनुमति देश के नाम पर की गई है। डिजाइन का सत्त्वाधिकार पंजीकरण की तारीख से दस वर्षों के लिए होगा जिसका विस्तार, अधिनियम एवं नियम के निबंधनों के अधीन, पाँच वर्षों की अतिरिक्त अवधि के लिए किया जा सकेगा। इस प्रमाण पत्र का उपयोग विधिक कार्यवाहियों अथवा विदेश में पंजीकरण प्राप्त करने के लिए नहीं हो सकता है।

*The reciprocity date (if any) which has been allowed and the name of the country. Copyright in the design will subsist for ten years from the date of Registration, and may under the terms of the Act and Rules, be extended for a further period of five years. This Certificate is not for use in legal proceedings or for obtaining registration abroad.



ORIGINAL

मूल/No : 136833



भारत सरकार
GOVERNMENT OF INDIA
पेटेंट कार्यालय
THE PATENT OFFICE
डिजाइन के पंजीकरण का प्रमाणपत्र
CERTIFICATE OF REGISTRATION OF DESIGN

डिजाइन सं. / Design No. : 348483-001
तारीख / Date : 27/08/2021
पारस्परिकता तारीख / Reciprocity Date* :
देश / Country :

प्रमाणित किया जाता है कि संलग्न प्रति में वर्णित डिजाइन जो **CENTERTABLE** से संबंधित है, का पंजीकरण, श्रेणी **06-03** में 1.Centurion University Of Technology And Management 2. Tapan Kumar Padhy 3.Hariharan Nelli 4.Dinesh Tej Kovelakonda 5.Suman Kumar Sudhanshu के नाम में उपर्युक्त संख्या और तारीख में कर लिया गया है।

Certified that the design of which a copy is annexed hereto has been registered as of the number and date given above in class **06-03** in respect of the application of such design to **CENTERTABLE** in the name of 1.Centurion University Of Technology And Management 2. Tapan Kumar Padhy 3.Hariharan Nelli 4.Dinesh Tej Kovelakonda 5.Suman Kumar Sudhanshu.

डिजाइन अधिनियम, 2000 तथा डिजाइन नियम, 2001 के अध्याधीन प्रावधानों के अनुसरण में।

In pursuance of and subject to the provisions of the Designs Act, 2000 and the Designs Rules, 2001.

INTELLECTUAL
PROPERTY INDIA
PATENTS | DESIGNS | TRADE MARKS
GEOGRAPHICAL INDICATIONS

निर्गमन की तारीख/Date of Issue : 23/05/2023

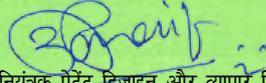
महानियंत्रक पेटेंट डिजाइन और व्यापार चिह्न
Controller General of Patents, Designs and Trade Marks

पारस्परिकता तारीख (यदि कोई हो) जिसकी अनुमति देश के नाम पर की गई है। डिजाइन का सत्त्वाधिकार पंजीकरण की तारीख से दस वर्षों के लिए होगा जिसका विस्तार, अधिनियम एवं नियम के निबंधनों के अधीन, पाँच वर्षों की अतिरिक्त अवधि के लिए किया जा सकेगा। इस प्रमाण पत्र का उपयोग विधिक कार्यवाहियों अथवा विदेश में पंजीकरण प्राप्त करने के लिए नहीं हो सकता है।

*The reciprocity date (if any) which has been allowed and the name of the country. Copyright in the design will subsist for ten years from the date of Registration, and may under the terms of the Act and Rules, be extended for a further period of five years. This Certificate is not for use in legal proceedings or for obtaining registration abroad.



ORIGINAL

मूल/No : 137966



भारत सरकार
GOVERNMENT OF INDIA
पेटेंट कार्यालय
THE PATENT OFFICE
डिजाइन के पंजीकरण का प्रमाणपत्र
CERTIFICATE OF REGISTRATION OF DESIGN

डिजाइन सं. / Design No. : 348486-001
तारीख / Date : 27/08/2021
पारस्परिकता तारीख / Reciprocity Date* :
देश / Country :

प्रमाणित किया जाता है कि संलग्न प्रति में वर्णित डिजाइन जो **LOFT BED** से संबंधित है, का पंजीकरण, श्रेणी **06-02** में 1. Centurion University Of Technology And Management 2. Tapan Kumar Padhy 3. Hariharan Nelli 4. Dinesh Tej Kovelakonda 5. Suman Kumar Sudhanshu के नाम में उपर्युक्त संख्या और तारीख में कर लिया गया है।

Certified that the design of which a copy is annexed hereto has been registered as of the number and date given above in class **06-02** in respect of the application of such design to **LOFT BED** in the name of 1. Centurion University Of Technology And Management 2. Tapan Kumar Padhy 3. Hariharan Nelli 4. Dinesh Tej Kovelakonda 5. Suman Kumar Sudhanshu.

डिजाइन अधिनियम, 2000 तथा डिजाइन नियम, 2001 के अध्याधीन प्रावधानों के अनुसरण में।

In pursuance of and subject to the provisions of the Designs Act, 2000 and the Designs Rules, 2001.

INTELLECTUAL
PROPERTY INDIA
PATENTS | DESIGNS | TRADE MARKS
GEOGRAPHICAL INDICATIONS

निर्गमन की तारीख/Date of Issue : 25/05/2023

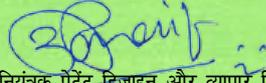
महानियंत्रक पेटेंट डिजाइन और व्यापार चिह्न
Controller General of Patents, Designs and Trade Marks

पारस्परिकता तारीख (यदि कोई हो) जिसकी अनुमति देश के नाम पर की गई है। डिजाइन का सत्त्वाधिकार पंजीकरण की तारीख से दस वर्षों के लिए होगा जिसका विस्तार, अधिनियम एवं नियम के निबंधनों के अधीन, पाँच वर्षों की अतिरिक्त अवधि के लिए किया जा सकेगा। इस प्रमाण पत्र का उपयोग विधिक कार्यवाहियों अथवा विदेश में पंजीकरण प्राप्त करने के लिए नहीं हो सकता है।

*The reciprocity date (if any) which has been allowed and the name of the country. Copyright in the design will subsist for ten years from the date of Registration, and may under the terms of the Act and Rules, be extended for a further period of five years. This Certificate is not for use in legal proceedings or for obtaining registration abroad.



ORIGINAL

मूल/No : 137213



भारत सरकार
GOVERNMENT OF INDIA
पेटेंट कार्यालय
THE PATENT OFFICE

डिजाइन के पंजीकरण का प्रमाणपत्र
CERTIFICATE OF REGISTRATION OF DESIGN

डिजाइन सं. / Design No. : 357338-001
तारीख / Date : 26/01/2022
पारस्परिकता तारीख / Reciprocity Date* :
देश / Country :

प्रमाणित किया जाता है कि संलग्न प्रति में वर्णित डिजाइन जो **E-GARBAGE DISPOSAL VAN** से संबंधित है, का पंजीकरण, श्रेणी **12-13** में 1.Centurion University Of Technology & Management (Cutm) 2. Avinash Kumar Singh 3.Mukundjee Pandey के नाम में उपर्युक्त संख्या और तारीख में कर लिया गया है।

Certified that the design of which a copy is annexed hereto has been registered as of the number and date given above in class **12-13** in respect of the application of such design to **E-GARBAGE DISPOSAL VAN** in the name of 1.Centurion University Of Technology & Management (Cutm) 2. Avinash Kumar Singh 3.Mukundjee Pandey.

डिजाइन अधिनियम, 2000 तथा डिजाइन नियम, 2001 के अध्याधीन प्रावधानों के अनुसरण में।

In pursuance of and subject to the provisions of the Designs Act, 2000 and the Designs Rules, 2001.

INTELLECTUAL
PROPERTY INDIA
PATENTS | DESIGNS | TRADE MARKS
GEOGRAPHICAL INDICATIONS

निर्गमन की तारीख/Date of Issue : 23/05/2023

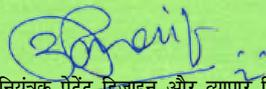
महानियंत्रक पेटेंट डिजाइन और व्यापार चिह्न
Controller General of Patents, Designs and Trade Marks

पारस्परिकता तारीख (यदि कोई हो) जिसकी अनुमति देश के नाम पर की गई है। डिजाइन का सत्त्वाधिकार पंजीकरण की तारीख से दस वर्षों के लिए होगा जिसका विस्तार, अधिनियम एवं नियम के निबंधनों के अधीन, पाँच वर्षों की अतिरिक्त अवधि के लिए किया जा सकेगा। इस प्रमाण पत्र का उपयोग विधिक कार्यवाहियों अथवा विदेश में पंजीकरण प्राप्त करने के लिए नहीं हो सकता है।

*The reciprocity date (if any) which has been allowed and the name of the country. Copyright in the design will subsist for ten years from the date of Registration, and may under the terms of the Act and Rules, be extended for a further period of five years. This Certificate is not for use in legal proceedings or for obtaining registration abroad.



ORIGINAL

मूल/No : 135884



भारत सरकार
GOVERNMENT OF INDIA
पेटेंट कार्यालय
THE PATENT OFFICE

डिजाइन के पंजीकरण का प्रमाणपत्र
CERTIFICATE OF REGISTRATION OF DESIGN

डिजाइन सं. / Design No. : 379893-001
तारीख / Date : 22/02/2023
पारस्परिकता तारीख / Reciprocity Date* :
देश / Country :

प्रमाणित किया जाता है कि संलग्न प्रति में वर्णित डिजाइन जो **RENEWABLE ENERGY POWERED POLES TO DETECT NOISE POLLUTION** से संबंधित है, का पंजीकरण, श्रेणी 10-05 में 1.Dr.Saine Sikta Dash 2. Dr.Sasmita Behera 3.Prof.Saswat Mishra 4.Dr.Siba Prasad Mishra 5.Prof. Deepak Kumar Sahu 6.Dr.Jyoti Prakash Giri 7.Dr.Prangya Parimita Pradhan 8.Prof.Priyanka Mishra 9.Prof.Nimay Chandra Giri के नाम में उपर्युक्त संख्या और तारीख में कर लिया गया है।

Certified that the design of which a copy is annexed hereto has been registered as of the number and date given above in class **10-05** in respect of the application of such design to **RENEWABLE ENERGY POWERED POLES TO DETECT NOISE POLLUTION** in the name of 1.Dr.Saine Sikta Dash 2. Dr.Sasmita Behera 3.Prof.Saswat Mishra 4.Dr.Siba Prasad Mishra 5.Prof. Deepak Kumar Sahu 6.Dr.Jyoti Prakash Giri 7.Dr.Prangya Parimita Pradhan 8.Prof.Priyanka Mishra 9.Prof.Nimay Chandra Giri.

डिजाइन अधिनियम, 2000 तथा डिजाइन नियम, 2001 के अध्याधीन प्रावधानों के अनुसरण में।

In pursuance of and subject to the provisions of the Designs Act, 2000 and the Designs Rules, 2001.

INTELLECTUAL
PROPERTY INDIA
PATENTS | DESIGNS | TRADE MARKS
GEOGRAPHICAL INDICATIONS

निर्गमन की तारीख/Date of Issue : 17/05/2023

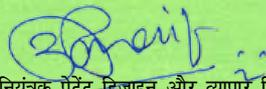
महानियंत्रक पेटेंट डिजाइन और व्यापार चिह्न
Controller General of Patents, Designs and Trade Marks

पारस्परिकता तारीख (यदि कोई हो) जिसकी अनुमति देश के नाम पर की गई है। डिजाइन का सत्त्वाधिकार पंजीकरण की तारीख से दस वर्षों के लिए होगा जिसका विस्तार, अधिनियम एवं नियम के निबंधनों के अधीन, पाँच वर्षों की अतिरिक्त अवधि के लिए किया जा सकेगा। इस प्रमाण पत्र का उपयोग विधिक कार्यवाहियों अथवा विदेश में पंजीकरण प्राप्त करने के लिए नहीं हो सकता है।

*The reciprocity date (if any) which has been allowed and the name of the country. Copyright in the design will subsist for ten years from the date of Registration, and may under the terms of the Act and Rules, be extended for a further period of five years. This Certificate is not for use in legal proceedings or for obtaining registration abroad.



ORIGINAL

मूल/No : 136484



भारत सरकार
GOVERNMENT OF INDIA
पेटेंट कार्यालय
THE PATENT OFFICE

डिजाइन के पंजीकरण का प्रमाणपत्र
CERTIFICATE OF REGISTRATION OF DESIGN

डिजाइन सं. / Design No. : 380508-001
तारीख / Date : 01/03/2023
पारस्परिकता तारीख / Reciprocity Date* :
देश / Country :

प्रमाणित किया जाता है कि संलग्न प्रति में वर्णित डिजाइन जो **SOLAR BIOMASS INTEGRATED CROP DRYER** से संबंधित है, का पंजीकरण, श्रेणी **15-03** में 1.Prof. Poulomi Chatterjee 2. Prof. Amit Kumar 3.Prof. Susovan Dutta 4.Dr. Susmita Das 5.Ar. Teesha Majumder 6.Dr. Sanjeeta Biswas 7.Dr. Devegowda S R 8.Prof. Prasheet Mishra 9.Dr.Nimay Chandra Giri के नाम में उपर्युक्त संख्या और तारीख में कर लिया गया है।

Certified that the design of which a copy is annexed hereto has been registered as of the number and date given above in class **15-03** in respect of the application of such design to **SOLAR BIOMASS INTEGRATED CROP DRYER** in the name of 1.Prof. Poulomi Chatterjee 2. Prof. Amit Kumar 3.Prof. Susovan Dutta 4.Dr. Susmita Das 5.Ar. Teesha Majumder 6.Dr. Sanjeeta Biswas 7.Dr. Devegowda S R 8.Prof. Prasheet Mishra 9.Dr.Nimay Chandra Giri.

डिजाइन अधिनियम, 2000 तथा डिजाइन नियम, 2001 के अध्याधीन प्रावधानों के अनुसरण में।

In pursuance of and subject to the provisions of the Designs Act, 2000 and the Designs Rules, 2001.

INTELLECTUAL
PROPERTY INDIA
PATENTS | DESIGNS | TRADE MARKS
GEOGRAPHICAL INDICATIONS

निर्गमन की तारीख/Date of Issue : 18/05/2023

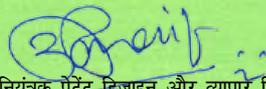
महानियंत्रक पेटेंट डिजाइन और व्यापार चिह्न
Controller General of Patents, Designs and Trade Marks

पारस्परिकता तारीख (यदि कोई हो) जिसकी अनुमति देश के नाम पर की गई है। डिजाइन का सत्त्वाधिकार पंजीकरण की तारीख से दस वर्षों के लिए होगा जिसका विस्तार, अधिनियम एवं नियम के निबंधनों के अधीन, पाँच वर्षों की अतिरिक्त अवधि के लिए किया जा सकेगा। इस प्रमाण पत्र का उपयोग विधिक कार्यवाहियों अथवा विदेश में पंजीकरण प्राप्त करने के लिए नहीं हो सकता है।

*The reciprocity date (if any) which has been allowed and the name of the country. Copyright in the design will subsist for ten years from the date of Registration, and may under the terms of the Act and Rules, be extended for a further period of five years. This Certificate is not for use in legal proceedings or for obtaining registration abroad.



ORIGINAL

मूल/No : 138096



भारत सरकार
GOVERNMENT OF INDIA
पेटेंट कार्यालय
THE PATENT OFFICE

डिजाइन के पंजीकरण का प्रमाणपत्र
CERTIFICATE OF REGISTRATION OF DESIGN

डिजाइन सं. / Design No. : 380801-001
तारीख / Date : 04/03/2023
पारस्परिकता तारीख / Reciprocity Date* :
देश / Country :

प्रमाणित किया जाता है कि संलग्न प्रति में वर्णित डिजाइन जो **FLOATING SOLAR PHOTOVOLTAIC CELL** से संबंधित है, का पंजीकरण, श्रेणी **13-04** में 1.Prof.Poulomi Chatterjee 2. Prof.Amit Kumar 3.Prof.Debasis Chatterjee 4.Prof.Susovan Dutta 5.Dr.Alivarani Mohapatra 6.Dr.Debani Prasad Mishra 7.Dr.Siba Prasad Mishra 8.Dr.Prangya Parimita Pradhan 9.Dr.Nimay Chandra Giri के नाम में उपर्युक्त संख्या और तारीख में कर लिया गया है।

Certified that the design of which a copy is annexed hereto has been registered as of the number and date given above in class **13-04** in respect of the application of such design to **FLOATING SOLAR PHOTOVOLTAIC CELL** in the name of 1.Prof.Poulomi Chatterjee 2. Prof.Amit Kumar 3.Prof.Debasis Chatterjee 4.Prof.Susovan Dutta 5.Dr.Alivarani Mohapatra 6.Dr.Debani Prasad Mishra 7.Dr.Siba Prasad Mishra 8.Dr.Prangya Parimita Pradhan 9.Dr.Nimay Chandra Giri.

डिजाइन अधिनियम, 2000 तथा डिजाइन नियम, 2001 के अध्याधीन प्रावधानों के अनुसरण में।

In pursuance of and subject to the provisions of the Designs Act, 2000 and the Designs Rules, 2001.

INTELLECTUAL
PROPERTY INDIA
PATENTS | DESIGNS | TRADE MARKS
GEOGRAPHICAL INDICATIONS

निर्गमन की तारीख/Date of Issue : 25/05/2023

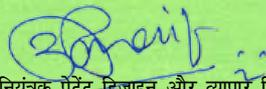
महानियंत्रक पेटेंट डिजाइन और व्यापार चिह्न
Controller General of Patents, Designs and Trade Marks

पारस्परिकता तारीख (यदि कोई हो) जिसकी अनुमति देश के नाम पर की गई है। डिजाइन का सत्त्वाधिकार पंजीकरण की तारीख से दस वर्षों के लिए होगा जिसका विस्तार, अधिनियम एवं नियम के निबंधनों के अधीन, पाँच वर्षों की अतिरिक्त अवधि के लिए किया जा सकेगा। इस प्रमाण पत्र का उपयोग विधिक कार्यवाहियों अथवा विदेश में पंजीकरण प्राप्त करने के लिए नहीं हो सकता है।

*The reciprocity date (if any) which has been allowed and the name of the country. Copyright in the design will subsist for ten years from the date of Registration, and may under the terms of the Act and Rules, be extended for a further period of five years. This Certificate is not for use in legal proceedings or for obtaining registration abroad.



ORIGINAL

मूल/No : 137345



भारत सरकार
GOVERNMENT OF INDIA
पेटेंट कार्यालय
THE PATENT OFFICE

डिजाइन के पंजीकरण का प्रमाणपत्र
CERTIFICATE OF REGISTRATION OF DESIGN

डिजाइन सं. / Design No. : 352888-001
तारीख / Date : 10/11/2021
पारस्परिकता तारीख / Reciprocity Date* :
देश / Country :

प्रमाणित किया जाता है कि संलग्न प्रति में वर्णित डिजाइन जो **A MEDICAL NEEDLE STERILIZATION BOX** से संबंधित है, का पंजीकरण, श्रेणी **24-02** में 1.Dr. Ranjan Kumar Mohapatra 2. Dr.Ashish Kumar Sarangi 3.Dr.Pranab Kishor Mohapatra 4.Dr.Alok Ranjan Sahu के नाम में उपर्युक्त संख्या और तारीख में कर लिया गया है।

Certified that the design of which a copy is annexed hereto has been registered as of the number and date given above in class **24-02** in respect of the application of such design to **A MEDICAL NEEDLE STERILIZATION BOX** in the name of 1.Dr. Ranjan Kumar Mohapatra 2. Dr.Ashish Kumar Sarangi 3.Dr.Pranab Kishor Mohapatra 4.Dr.Alok Ranjan Sahu.

डिजाइन अधिनियम, 2000 तथा डिजाइन नियम, 2001 के अध्याधीन प्रावधानों के अनुसरण में।

In pursuance of and subject to the provisions of the Designs Act, 2000 and the Designs Rules, 2001.

INTELLECTUAL
PROPERTY INDIA
PATENTS | DESIGNS | TRADE MARKS
GEOGRAPHICAL INDICATIONS

निर्गमन की तारीख/Date of Issue : 23/05/2023

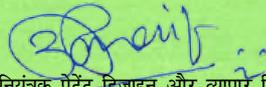

महानियंत्रक पेटेंट डिजाइन और व्यापार चिह्न
Controller General of Patents, Designs and Trade Marks

पारस्परिकता तारीख (यदि कोई हो) जिसकी अनुमति देश के नाम पर की गई है। डिजाइन का सत्त्वाधिकार पंजीकरण की तारीख से दस वर्षों के लिए होगा जिसका विस्तार, अधिनियम एवं नियम के निबंधनों के अधीन, पाँच वर्षों की अतिरिक्त अवधि के लिए किया जा सकेगा। इस प्रमाण पत्र का उपयोग विधिक कार्यवाहियों अथवा विदेश में पंजीकरण प्राप्त करने के लिए नहीं हो सकता है।

*The reciprocity date (if any) which has been allowed and the name of the country. Copyright in the design will subsist for ten years from the date of Registration, and may under the terms of the Act and Rules, be extended for a further period of five years. This Certificate is not for use in legal proceedings or for obtaining registration abroad.

ORIGINAL

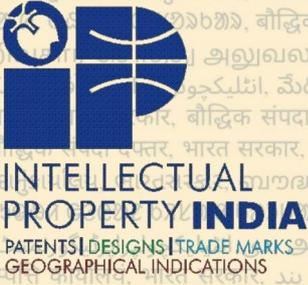
क्रम सं/ Serial No. : 139064



INTELLECTUAL PROPERTY INDIA PATENTS | DESIGNS | TRADE MARKS | GEOGRAPHICAL INDICATIONS

सत्यमेव जयते

पेटेंट कार्यालय, भारत सरकार | The Patent Office, Government Of India

डिजाइन के पंजीकरण का प्रमाण पत्र | Certificate of Registration of Design

डिजाइन सं. / Design No. : 348488-001

तारीख / Date : 27/08/2021

पारस्परिकता तारीख / Reciprocity Date* :

देश / Country :

प्रमाणित किया जाता है कि संलग्न प्रति में वर्णित डिजाइन जो SOFA SET से संबंधित है, का पंजीकरण, श्रेणी 06-01

में 1.Centurion University Of Technology And Management 2. Tapan Kumar Padhy

3.Hariharan Nelli 4.Dinesh Tej Kovelakonda 5.Suman Kumar Sudhanshu के नाम में उपर्युक्त

संख्या और तारीख में कर लिया गया है।

Certified that the design of which a copy is annexed hereto has been registered as of the number and date given above in class 06-01 in respect of the application of such design to SOFA SET in the name of 1.Centurion University Of Technology And Management 2. Tapan Kumar Padhy 3.Hariharan Nelli 4.Dinesh Tej Kovelakonda 5.Suman Kumar Sudhanshu.

डिजाइन अधिनियम, 2000 तथा डिजाइन नियम, 2001 के अधधीन प्रावधानों के अनुसरण में।

In pursuance of and subject to the provisions of the Designs Act, 2000 and the Designs Rules, 2001.

जारी करने की तिथि : 07/06/2023
Date of Issue



[Signature]

महानियंत्रक पेटेंट, डिजाइन और व्यापार चिह्न
Controller General of Patents, Designs and Trade Marks

*पारस्परिकता तारीख (यदि कोई हो) जिसकी अनुमति दी गई है तथा देश का नाम। डिजाइन का स्वत्वाधिकार पंजीकरण की तारीख से दस वर्षों के लिए होगा जिसका विस्तार, अधिनियम एवं नियम के निबंधनों के अधीन, पाँच वर्षों की अतिरिक्त अवधि के लिए किया जा सकेगा। इस प्रमाण पत्र का उपयोग विधिक कार्यवाहियों अथवा विदेश में पंजीकरण प्राप्त करने के लिए नहीं हो सकता है।

The reciprocity date (if any) which has been allowed and the name of the country. Copyright in the design will subsist for ten years from the date of Registration, and may under the terms of the Act and Rules, be extended for a further period of five years. This Certificate is not for use in legal proceedings or for obtaining registration abroad.



Intellectual
Property
Office

Certificate of Registration for a UK Design

Design number: 6285107

Grant date: 09 June 2023

Registration date: 24 May 2023

This is to certify that,

in pursuance of and subject to the provision of Registered Designs Act 1949, the design of which a representation or specimen is attached, had been registered as of the date of registration shown above in the name of

Dr. Ashok Misra, Dr. Banitamani Mallik, Ms. Nagalapalli Jeebaratnam, Ms.

Gedala Sridevi, Dr. Sujit Mishra, Mr. Debarghya De, Ms. Priya Khanda

in respect of the application of such design to:

Water quality prediction device

International Design Classification:

Version: 14-2023

Class: 10 CLOCKS AND WATCHES AND OTHER MEASURING INSTRUMENTS, CHECKING AND SIGNALLING INSTRUMENTS

Subclass: 05 INSTRUMENTS, APPARATUS AND DEVICES FOR CHECKING, SECURITY OR TESTING

Adam Williams

Comptroller-General of Patents, Designs and Trade Marks

Intellectual Property Office

The attention of the Proprietor(s) is drawn to the important notes overleaf.



Representation of Designs









Intellectual Property Office is an operating name of the Patent Office

www.gov.uk/ipo



Design details

Design application number
6285107

Filing date (provisional)
24 May 2023

Defer registration
No

Design
Water quality prediction device

Additional description
Water quality prediction device

Illustration disclaimer
No claim is made to the colour shown in the drawings

Illustrations

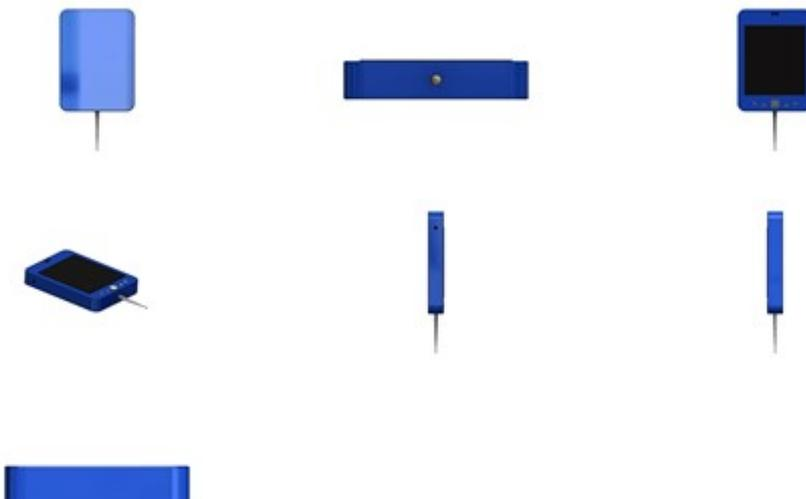

Repeated surface pattern
No

Priority claims

None

Owner details

Dr. Ashok Misra

Professor, Department of Mathematics, Centurion University of Technology and Management, Paralakhemundi, Aluri Nagar, R.Sithapur, Upalada, Gajapati, Odisha, 761211, India

Dr. Banitamani Mallik

Professor, Department of Mathematics, Centurion University of Technology and Management, Paralakhemundi, Aluri Nagar, R.Sithapur, Upalada, Gajapati, Odisha, 761211, India

Ms. N Jeebaratnam

Assistant Professor, Department of ECE, Centurion University of Technology and Management, Paralakhemundi, Aluri Nagar, R.Sithapur, Upalada, Gajapati, Odisha, 761211, India

Ms. G Sreedevi

Assistant Professor, Department of ME, Centurion University of Technology and Management, Paralakhemundi, Aluri Nagar, R.Sithapur, Upalada, Gajapati, Odisha, 761211, India

Dr. Sujit Mishra

Assistant Professor, Department of ME, Centurion University of Technology and Management, Paralakhemundi, Aluri Nagar, R.Sithapur, Upalada, Gajapati, Odisha, 761211, India

Mr. Debarghya De

Student, Department of Agriculture Engineering, Centurion University of Technology and Management, Paralakhemundi, Aluri Nagar, R.Sithapur, Upalada, Gajapati, Odisha, 761211, India

Ms. Priya Khanda

Student, Department of Agriculture Engineering, Centurion University of Technology and Management, Paralakhemundi, Aluri Nagar, R.Sithapur, Upalada, Gajapati, Odisha, 761211, India

Contact details



Reference: LXG 3994

Please note this is an uncertified copy of your registration document which you can use for research or personal use.

Design Application Details

Application Number:	381334-001
Cbr Number:	203171
Cbr Date:	12/03/2023 13:51:11
Applicant Name:	1. Dr. Dharmendra Ahuja 2. Hemlata Rathore 3. Ankit Kumar 4. Shmriti 5. Dr. Nihar Ranjan Kar 6. Ms. Linda Xavier 7. Mr. Abhijit Gupta

Design Application Status

Application Status: Design Accepted and Published, Journal No is 22/2023 and Journal Date is 02/06/2023

[Back](#)

Design Number	381334-001	
Class	10-05	
1. Dr. Dharmendra Ahuja Dean, Faculty of Pharmaceutical Science, Jayoti Vidyapeeth Women's University, Jaipur, Rajasthan, India 303122. 2. Hemlata Rathore Assistant Professor, Department of Pharmacognosy, School of Pharmacy Chouksey Engineering College Bilaspur, Chhattisgarh-495004, India. 3. Ankit Kumar Assistant Professor, Department of Paramedical Sciences, Subharti Medical College, Swami Vivekanand Subharti University, Meerut, Uttar Pradesh-250005, India. 4. Shmriti Assistant Professor, Department of Paramedical Sciences, Subharti Medical College, Swami Vivekanand Subharti University, Meerut, Uttar Pradesh-250005, India. , et al.		
Date of Registration	12/03/2023	
Title	TRANSDERMAL ALCOHOL MONITORING DEVICE	
Priority NA		

ORIGINAL

क्रम सं/ Serial No. : 138629



INTELLECTUAL PROPERTY INDIA PATENTS | DESIGNS | TRADE MARKS | GEOGRAPHICAL INDICATIONS



सत्यमेव जयते

पेटेंट कार्यालय, भारत सरकार

The Patent Office, Government Of India

डिजाइन के पंजीकरण का प्रमाण पत्र

Certificate of Registration of Design

डिजाइन सं. / Design No.

381334-001

तारीख / Date

12/03/2023

पारस्परिकता तारीख / Reciprocity Date*

देश / Country

प्रमाणित किया जाता है कि संलग्न प्रति में वर्णित डिजाइन जो TRANSDERMAL ALCOHOL MONITORING DEVICE से संबंधित है, का पंजीकरण, श्रेणी 10-05 में 1.Dr. Dharmendra Ahuja 2. Hemlata Rathore 3.Ankit Kumar 4.Shmriti 5.Dr. Nihar Ranjan Kar 6.Ms. Linda Xavier 7.Mr. Abhijit Gupta के नाम में उपर्युक्त संख्या और तारीख में कर लिया गया है।

Certified that the design of which a copy is annexed hereto has been registered as of the number and date given above in class 10-05 in respect of the application of such design to TRANSDERMAL ALCOHOL MONITORING DEVICE in the name of 1.Dr. Dharmendra Ahuja 2. Hemlata Rathore 3.Ankit Kumar 4.Shmriti 5.Dr. Nihar Ranjan Kar 6.Ms. Linda Xavier 7.Mr. Abhijit Gupta.

डिजाइन अधिनियम, 2000 तथा डिजाइन नियम, 2001 के अधधीन प्रावधानों के अनुसरण में।

In pursuance of and subject to the provisions of the Designs Act, 2000 and the Designs Rules, 2001.

जारी करने की तिथि : 01/06/2023 Date of Issue



Handwritten signature

महानियंत्रक पेटेंट, डिजाइन और व्यापार चिह्न Controller General of Patents, Designs and Trade Marks

*पारस्परिकता तारीख (यदि कोई हो) जिसकी अनुमति दी गई है तथा देश का नाम। डिजाइन का स्वत्वाधिकार पंजीकरण की तारीख से दस वर्षों के लिए होगा जिसका विस्तार, अधिनियम एवं नियम के निबंधनों के अधीन, पाँच वर्षों की अतिरिक्त अवधि के लिए किया जा सकेगा। इस प्रमाण पत्र का उपयोग विधिक कार्यवाहियों अथवा विदेश में पंजीकरण प्राप्त करने के लिए नहीं हो सकता है। The reciprocity date (if any) which has been allowed and the name of the country. Copyright in the design will subsist for ten years from the date of Registration, and may under the terms of the Act and Rules, be extended for a further period of five years. This Certificate is not for use in legal proceedings or for obtaining registration abroad.



Intellectual
Property
Office

Certificate of Registration for a UK Design

Design number: 6264907

Grant date: 07 March 2023

Registration date: 28 February 2023

This is to certify that,

in pursuance of and subject to the provision of Registered Designs Act 1949, the design of which a representation or specimen is attached, had been registered as of the date of registration shown above in the name of

Mr. Brijesh Kumar Saroj, Mr. Mohammad Muztaba, Ms. Sarita Verma, Dr. R.

Rajagopalan, Dr. Farhad F Mehta, Dr. Bhuwanendra Singh , Mrs. Mughisa

Nagori, Dr. Akhilesh Patel, Mr. Mohammad Haneef, Dr. Nihar Ranjan Kar

in respect of the application of such design to:

GLASS APPARATUS FOR SEPARATING PARTICLES FROM

PHARMACEUTICAL NANOSUSPENSION

International Design Classification:

Version: 14-2023

Class: 24 MEDICAL AND LABORATORY EQUIPMENT

Subclass: 02 MEDICAL INSTRUMENTS, INSTRUMENTS AND TOOLS FOR LABORATORY USE

Adam Williams

Comptroller-General of Patents, Designs and Trade Marks
Intellectual Property Office

The attention of the Proprietor(s) is drawn to the important notes overleaf.



Representation of Designs

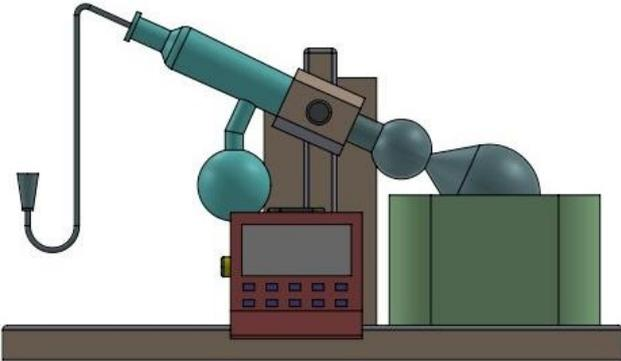
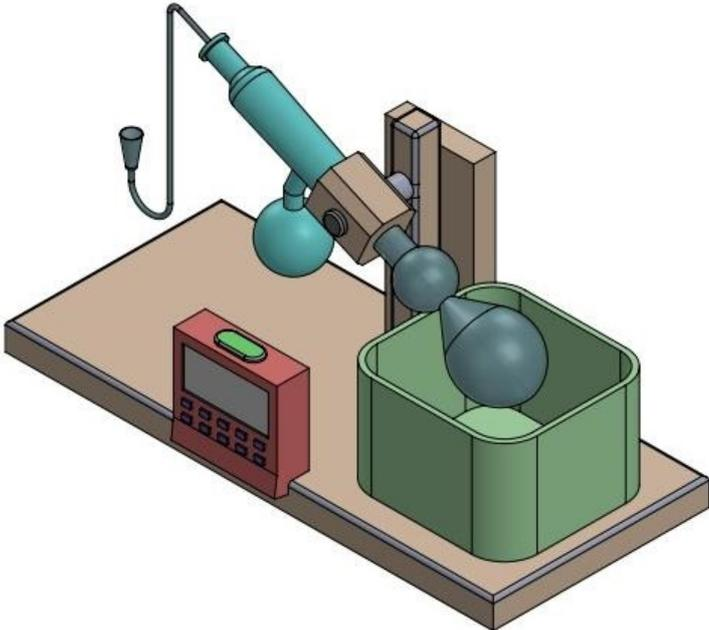

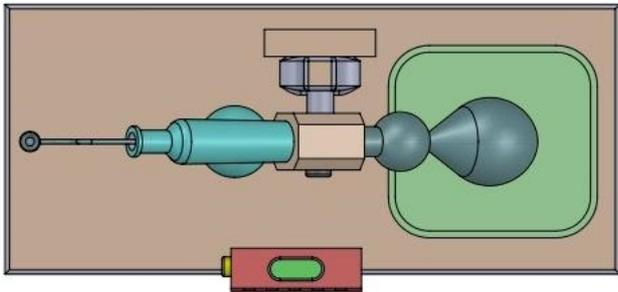
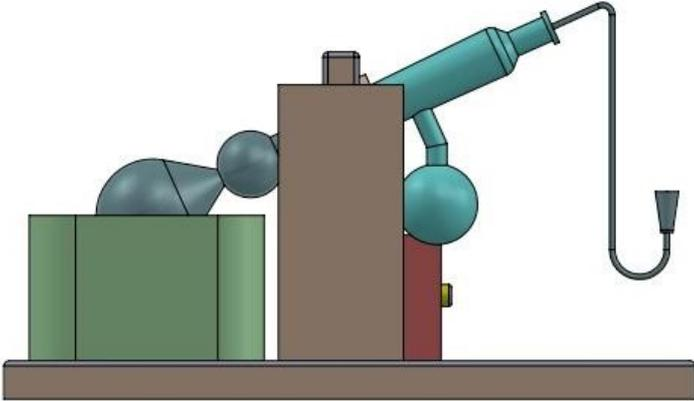

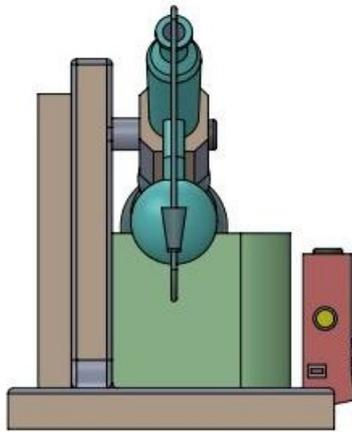
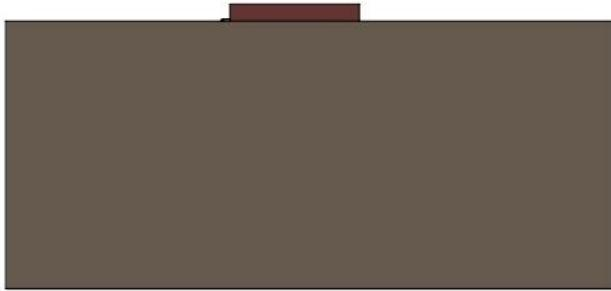

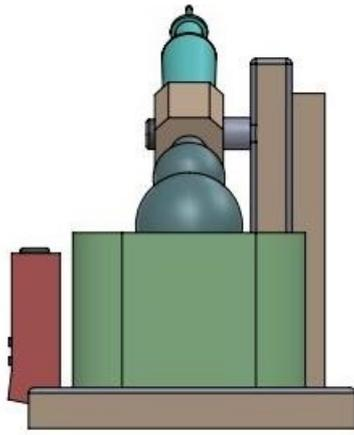

Intellectual Property Office is an operating name of the Patent Office

www.gov.uk/ipo



Intellectual
Property
Office

Certificate of Registration for a UK Design

Design number: 6288630

Grant date: 17 June 2023

Registration date: 08 June 2023

This is to certify that,

in pursuance of and subject to the provision of Registered Designs Act 1949, the design of which a representation or specimen is attached, had been registered as of the date of registration shown above in the name of

Dr. Chinmaya Mahapatra, Dr. Subas Chandra Dinda, Dr. Hara Prasad Mishra,

Ms. Smruti Sikta Mishra, Mr. Abhra Das, Dr. Lubhan Singh, Mr.Om Prakash

Panda, Mr.Sanatan Nayak

in respect of the application of such design to:

IOT Device for Breast Cancer Detection

International Design Classification:

Version: 14-2023

Class: 24 MEDICAL AND LABORATORY EQUIPMENT

Subclass: 01 APPARATUS AND EQUIPMENT FOR DOCTORS, HOSPITALS
AND LABORATORIES

Adam Williams

Comptroller-General of Patents, Designs and Trade Marks

Intellectual Property Office

The attention of the Proprietor(s) is drawn to the important notes overleaf.



Representation of Designs

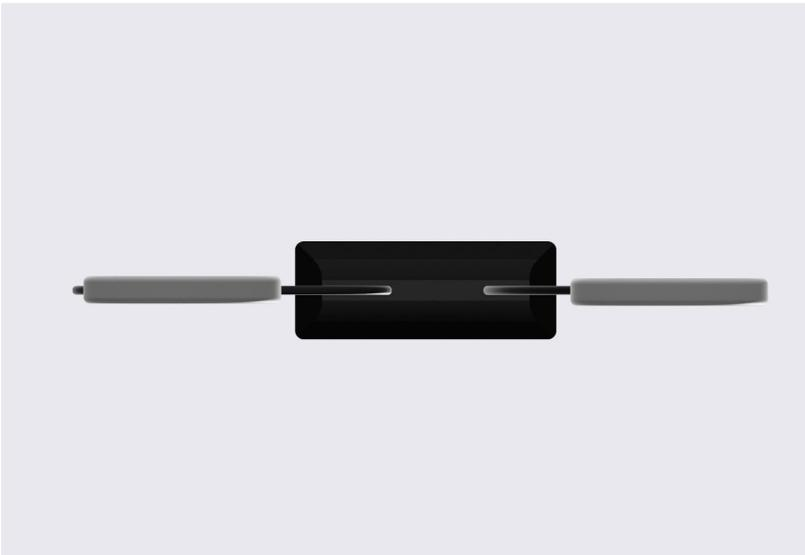

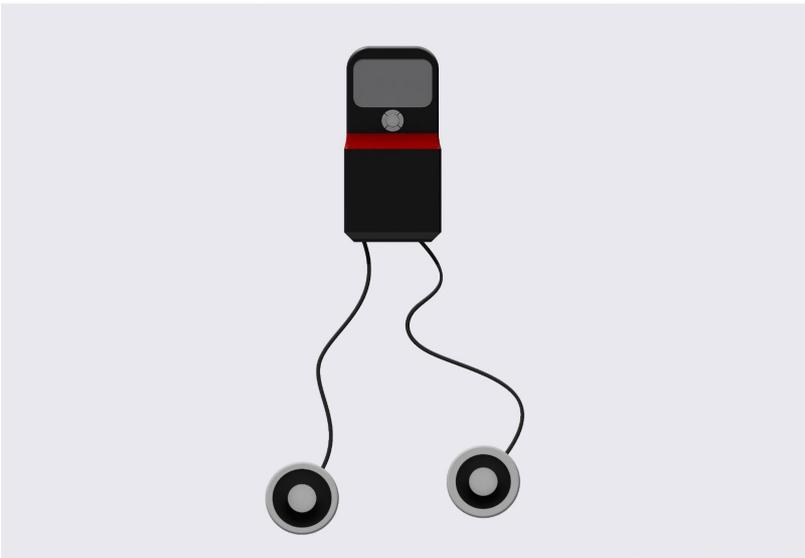

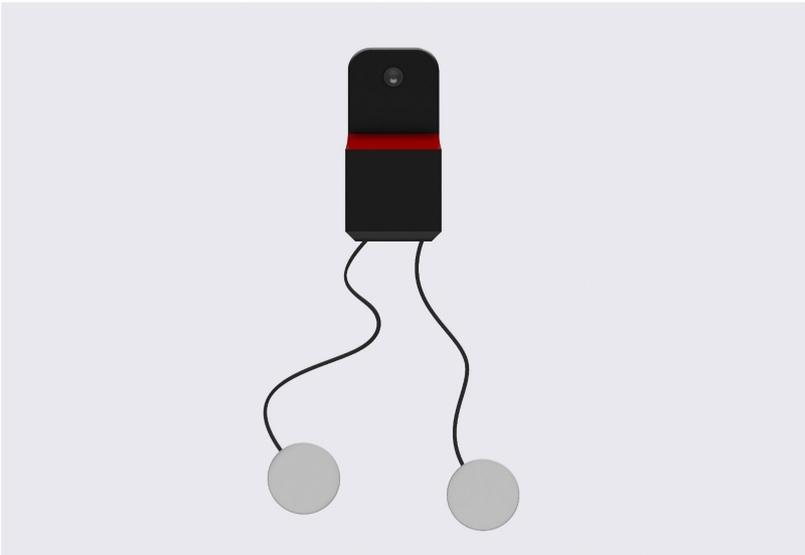
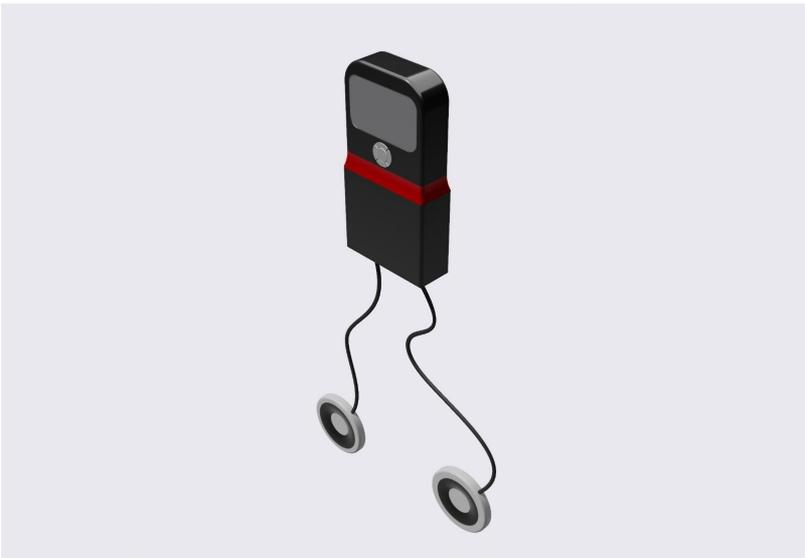



Intellectual Property Office is an operating name of the Patent Office

www.gov.uk/ipo



Intellectual
Property
Office

Certificate of Registration for a UK Design

Design number: 6307009

Grant date: 09 September 2023

Registration date: 01 September 2023

This is to certify that,

in pursuance of and subject to the provision of Registered Designs Act 1949, the design of which a representation or specimen is attached, had been registered as of the date of registration shown above in the name of

Dr.Ashish Kumar Sarangi, Dr.Himansu Bhusan Samal, Dr.Fahima Dilnawaz,

Dr.Kalpita Bhatta

in respect of the application of such design to:

Laparoscopic Instruments

International Design Classification:

Version: 14-2023

Class: 24 MEDICAL AND LABORATORY EQUIPMENT

Subclass: 02 MEDICAL INSTRUMENTS, INSTRUMENTS AND TOOLS FOR LABORATORY USE

Adam Williams

Comptroller-General of Patents, Designs and Trade Marks

Intellectual Property Office

The attention of the Proprietor(s) is drawn to the important notes overleaf.



Representation of Designs

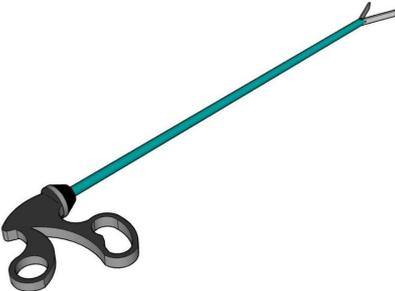

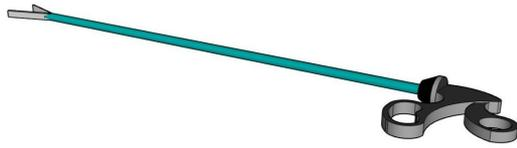
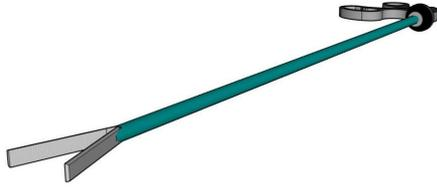

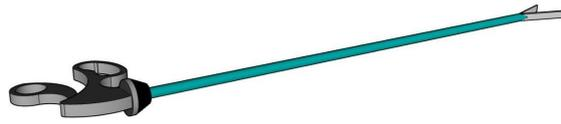
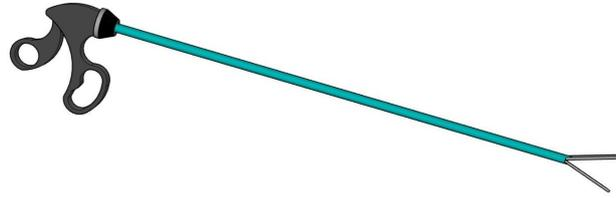

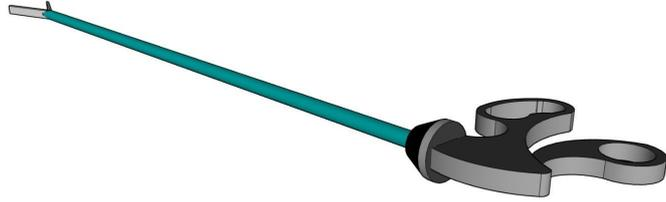

Intellectual Property Office is an operating name of the Patent Office

www.gov.uk/ipo



Intellectual
Property
Office

Certificate of Registration for a UK Design

Design number: 6300181

Grant date: 08 August 2023

Registration date: 29 July 2023

This is to certify that,

in pursuance of and subject to the provision of Registered Designs Act 1949, the design of which a representation or specimen is attached, had been registered as of the date of registration shown above in the name of

Prof. (Dr.) Seema Tomar , Dr.Nasyam Mohammed Akram, Dr. Shaveta Ahalwat,

Mr. Sonu Dewaji Gathe, Dr. Thoppalada. Yunus Pasha, Ajay Kumar Verma, Dr.

Swati Gupta, Dr. Gyanranjan Mahalik, Dr. Annu Mudgal, Ms.Praneetha

Visampalli

in respect of the application of such design to:

DOUBLE DISTILLATION APPARATUS FOR SEPARATION OF ORGANIC

COMPOUNDS

International Design Classification:

Version: 14-2023

Class: 24 MEDICAL AND LABORATORY EQUIPMENT

Subclass: 02 MEDICAL INSTRUMENTS, INSTRUMENTS AND TOOLS FOR LABORATORY USE

Adam Williams

Comptroller-General of Patents, Designs and Trade Marks

Intellectual Property Office

The attention of the Proprietor(s) is drawn to the important notes overleaf.



Representation of Designs

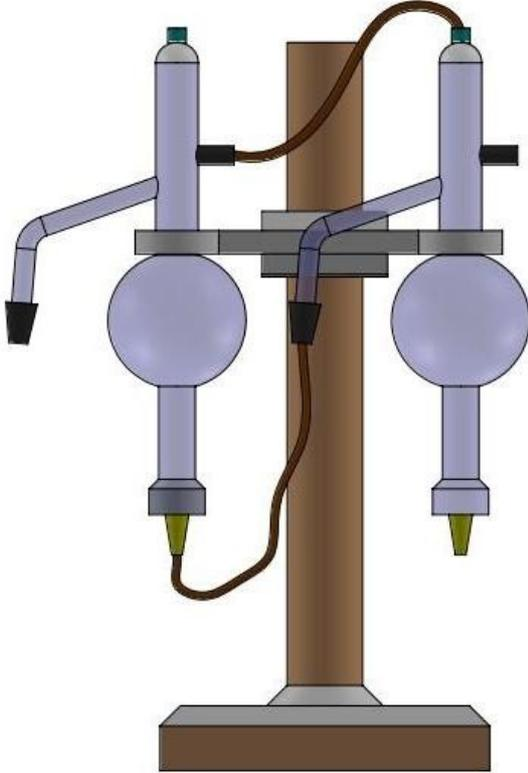
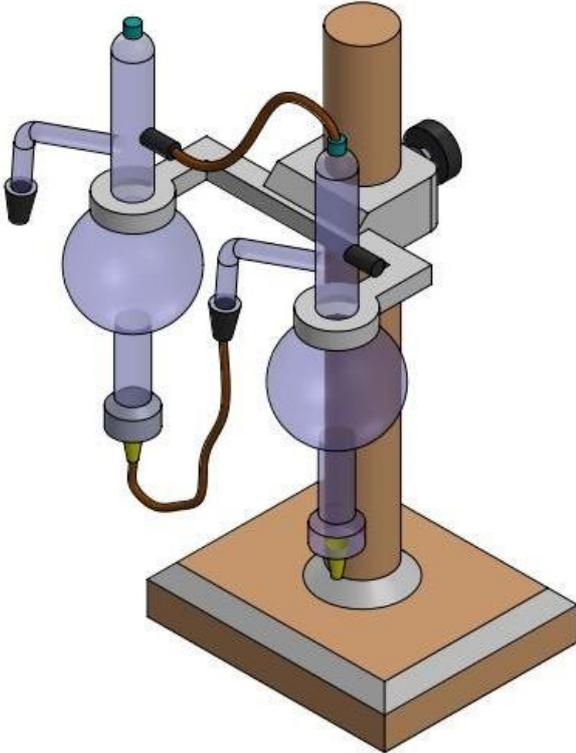

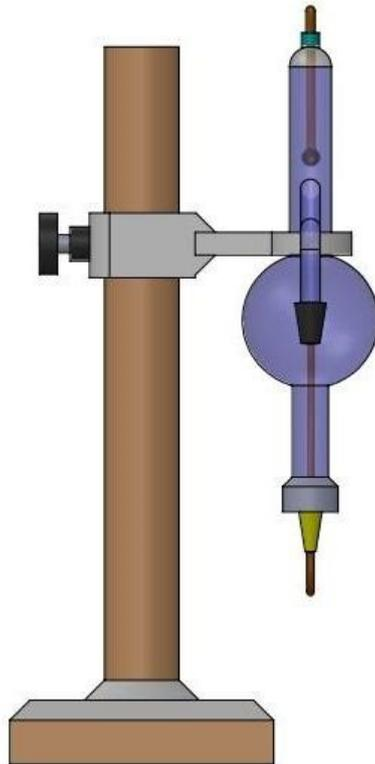
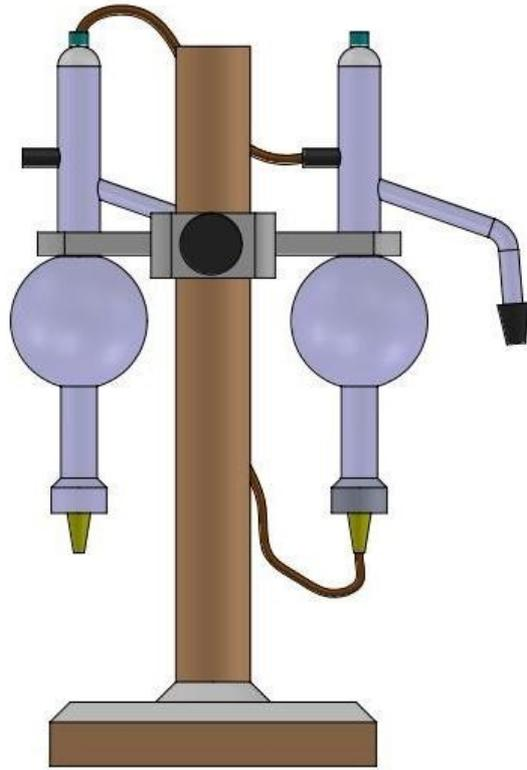

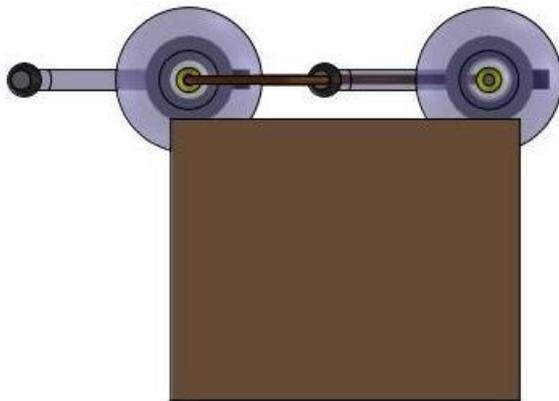
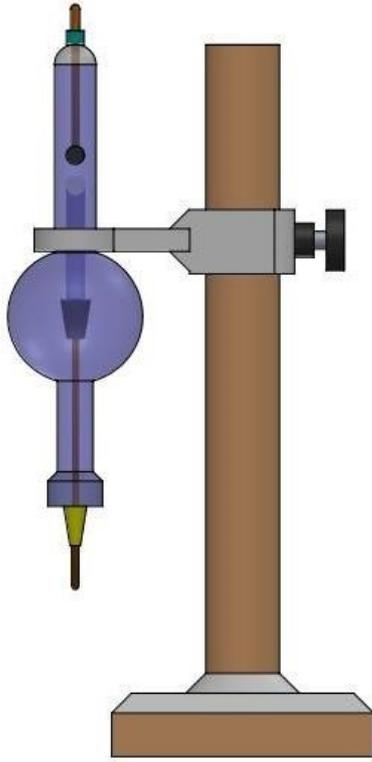

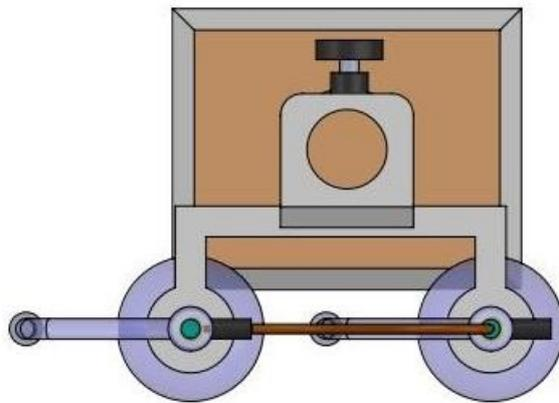

Intellectual Property Office is an operating name of the Patent Office

www.gov.uk/ipo



Intellectual
Property
Office

Certificate of Registration for a UK Design

Design number: 6310504

Grant date: 23 September 2023

Registration date: 14 September 2023

This is to certify that,

in pursuance of and subject to the provision of Registered Designs Act 1949, the design of which a representation or specimen is attached, had been registered as of the date of registration shown above in the name of

Prof. (Dr.) Varsha Deva, Razique Anwer, Shoeb Mustafa, Saif Ahmed, Seema

Paragannavar, Dr Chakrapani Ramesh, Dr. Soumya Jal, Binapani Barik, Dr.

Harshal Ashok Pawar, Dr Vashisth Pankajkumar Bhavsar

in respect of the application of such design to:

Device to detect anticancer activity of coumarin derivatives

International Design Classification:

Version: 14-2023

Class: 24 MEDICAL AND LABORATORY EQUIPMENT

Subclass: 01 APPARATUS AND EQUIPMENT FOR DOCTORS, HOSPITALS
AND LABORATORIES

Adam Williams

Comptroller-General of Patents, Designs and Trade Marks

Intellectual Property Office

The attention of the Proprietor(s) is drawn to the important notes overleaf.



Representation of Designs

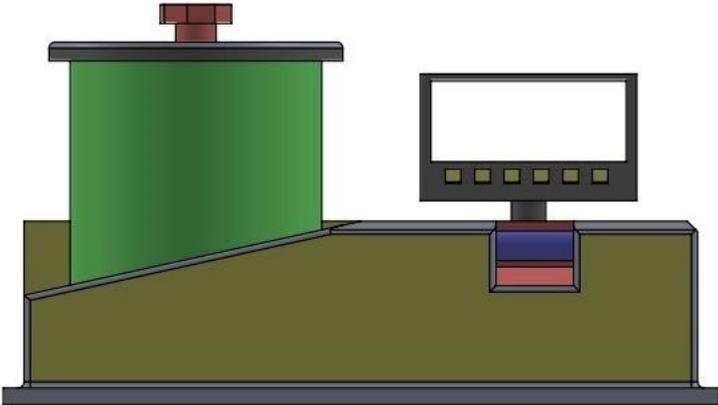
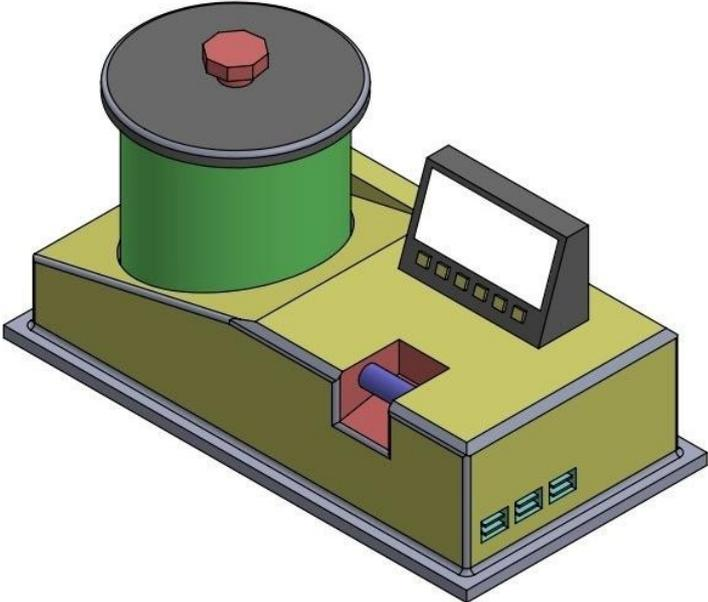

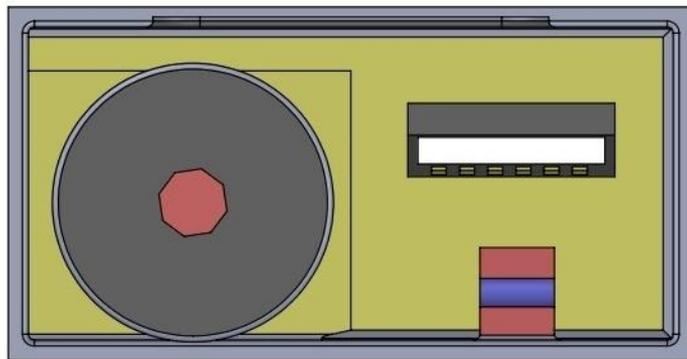
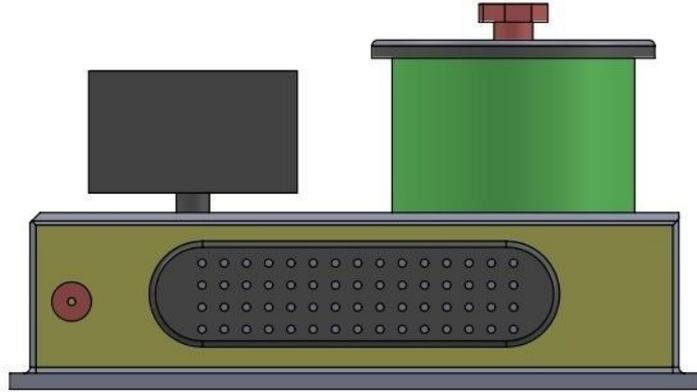

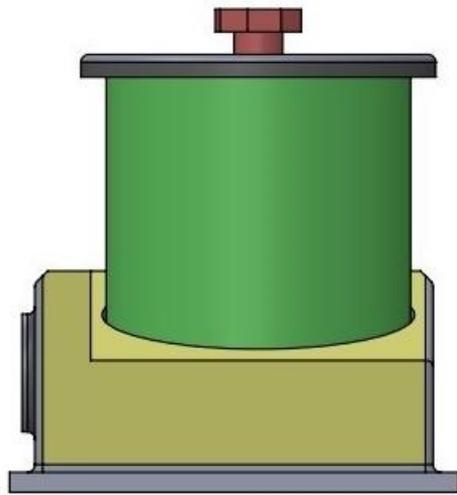

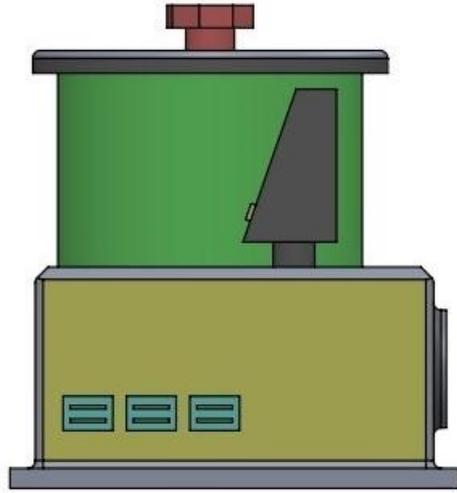

Intellectual Property Office is an operating name of the Patent Office

www.gov.uk/ipo



Intellectual
Property
Office

Certificate of Registration for a UK Design

Design number: 6316607

Grant date: 10 October 2023

Registration date: 03 October 2023

This is to certify that,

in pursuance of and subject to the provision of Registered Designs Act 1949, the design of which a representation or specimen is attached, had been registered as of the date of registration shown above in the name of

Mr. Abhinav Anand, Mr. Suman Kumar Mekap, Dr. Sandhya Subhadra,

Kuchibhotla Phani Sarada Praneetha , Sabita Sahoo, Satyabrata Jena, Ms.

Neelam Kumari , Dr. Daisy Sharma

in respect of the application of such design to:

ELECTROCONVULSIOMETER APPARATUS

International Design Classification:

Version: 14-2023

Class: 24 MEDICAL AND LABORATORY EQUIPMENT

Subclass: 01 APPARATUS AND EQUIPMENT FOR DOCTORS, HOSPITALS
AND LABORATORIES

Adam Williams

Comptroller-General of Patents, Designs and Trade Marks

Intellectual Property Office

The attention of the Proprietor(s) is drawn to the important notes overleaf.



Intellectual Property Office is an operating name of the Patent Office

www.gov.uk/ipo

Representation of Designs

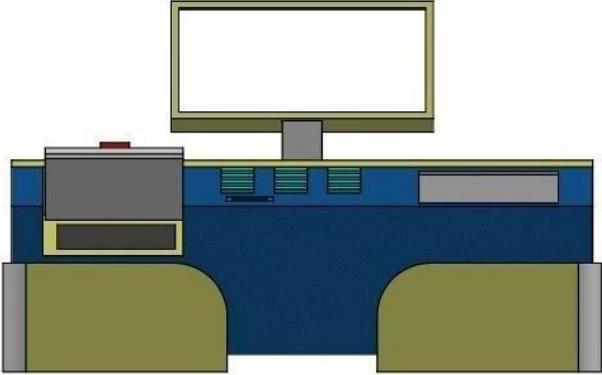
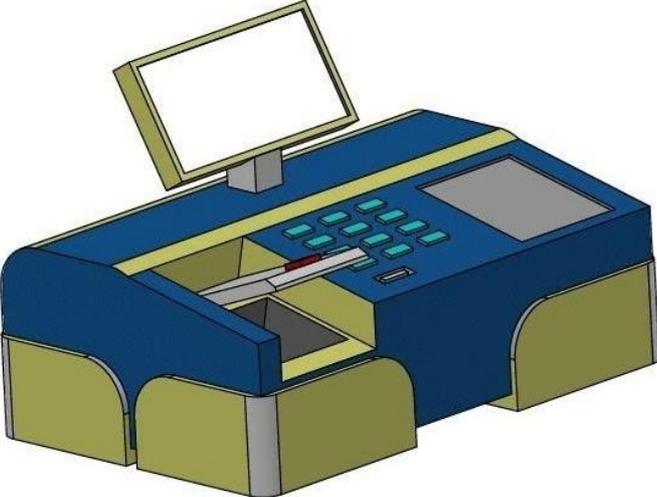

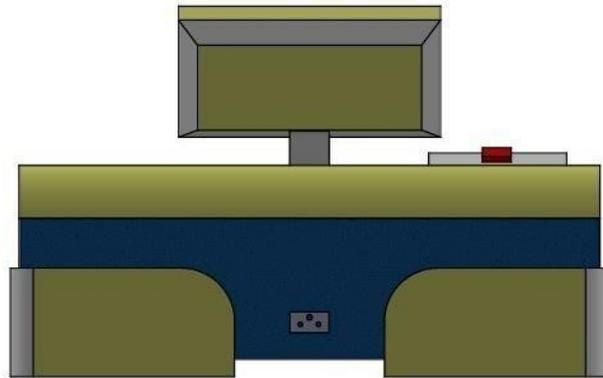

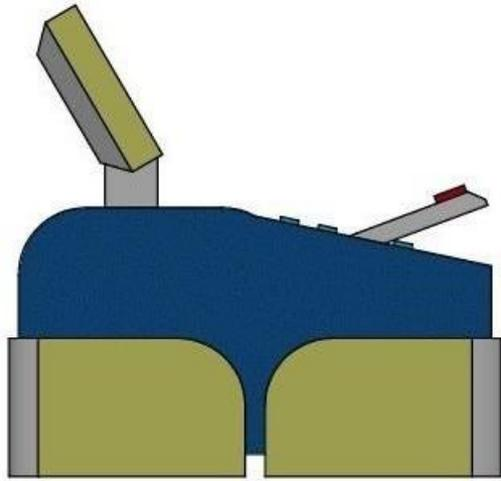
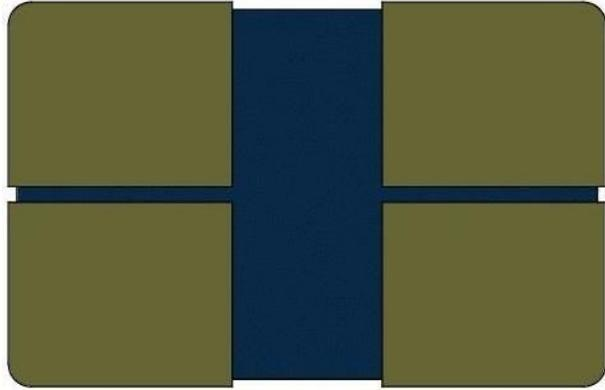

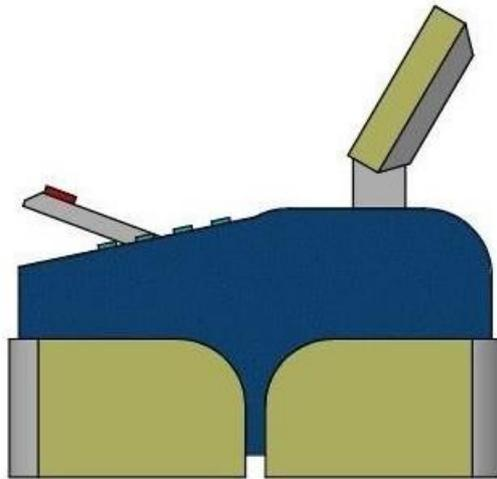

Intellectual Property Office is an operating name of the Patent Office

www.gov.uk/ipo

